



Version 1.1

SY-03B Syringe Pump User's Manual

南京润泽流体控制设备有限公司
NANJING RUNZE FLUID CONTROL EQUIPMENT CO.LTD

Table of Contents

Chapter1 Getting Started.....	4
1.1 SY03B Features at-a-Glance.....	4
1.2 Unpacking the SY03B.....	5
1.3 ESD Considerations.....	5
1.4 Functional Description of the SY03B.....	5
1.4.1 Syringe and Syringe Drive.....	5
1.4.2 Valve and Valve Drive.....	6
1.4.3 Printed Circuit Assembly.....	7
1.4.4 Communication Interfaces.....	7
1.4.5 Multi-Pump Configurations.....	8
1.5 Safety.....	8
1.5.1 Notices and Symbols.....	8
1.6 Tips for Setting Up the SY03B.....	9
Chapter2 Hardware Setup.....	10
2.1 Power and Electrical Considerations.....	10
2.1.1 Choosing a Power Supply.....	10
2.1.2 Integrating a Power Supply.....	10
2.1.3 Switching Power Supplies.....	11
2.2 Cabling.....	11
2.3 Communication Interfaces.....	12
2.3.1 RS232/RS485Interface.....	13
2.4 Settings and Options.....	14
2.4.1 Configuration Commands.....	14
2.4.2 Address Switch Settings.....	14
2.4.3 Self-Test.....	14
2.4.4 P11 Inputs/Outputs.....	15
2.5 Installing Components.....	15
2.5.1 Installing the SY03B Valve.....	15
2.5.2 Installing a Syringe.....	15
2.6 Mounting.....	16
Chapter3 Software Communication.....	17
3.1 SY03B Addressing Scheme.....	18
3.2 Communication Protocols.....	19

3.2.1 OEM Communication Protocol.....	19
3.2.2 Data Terminal (DT) Protocol.....	21
3.2.3 Using DT Protocol with Microsoft Windows.....	23
3.3 Using the SY03B Command Set.....	23
3.3.1 Command Execution Guidelines.....	23
3.3.2 Pump Configuration Commands.....	24
3.4 Initialization.....	26
3.4.1 Initialization Forces.....	26
3.4.2 Initialization Commands.....	27
3.5 Operating Commands.....	29
3.5.1 Valve Commands.....	29
3.5.2 Plunger Movement Commands.....	34
3.5.3 Set Commands (Speed and Acceleration).....	35
3.5.4 Interaction of Set Commands.....	40
3.5.5 Control Commands.....	40
3.5.6 Non-Volatile Memory (EEPROM) Commands.....	43
3.5.7 Report Commands.....	45
3.6 Error Codes and Pump Status.....	47
3.6.1 Status Bit.....	47
3.6.2 Error Codes.....	48
3.6.3 Error Types.....	49
Chapter4 Setting Up the SY03B for Application.....	52
4.1 Glossary.....	52
4.2 Optimizing SY03B Performance.....	54
4.3 Helpful Hints.....	57
A Communication Commands.....	58
B Command Quick Reference.....	58
B.1 Pump Configuration Commands.....	58
B.2 Initialization Commands.....	59
B.3 Valve Commands.....	60
B.4 Plunger Movement Commands/Status Bit Reports.....	60
B.5 Non-Volatile Memory (EEPROM) Commands.....	60
B.6 Report Commands.....	61
B.7 Error Codes and Status Byte.....	61

Chapter1 Getting Started

Congratulations on your purchase of the SY-03B Syringe Pump from Runze Fluid Tech Company.

SY-03B Syringe Pump is a fully programmable, open frame, precision liquid handling pump module, designed for applications in the 25 μ L to 25 mL range. It is controlled by an external computer or microprocessor and automates pipetting, diluting, and dispensing functions.

This chapter includes these topics:

- ◆ SY03B Features at-a-Glance
- ◆ Unpacking the SY03B
- ◆ Functional Description of the SY03B
- ◆ Safety
- ◆ Tips for Setting Up the SY03B

1.1 SY03B Features at-a-Glance

SY03B is a syringe pump that is designed for OEM precision liquid handling applications. It has the following standard features and functions:

- ◆ Syringe sizes ranging from 25 μ L to 25mL
- ◆ Accuracy < 1.0% at full stroke
- ◆ Precision \leq 0.05% at full stroke
- ◆ Standard dispense/aspirate resolution of 6,000 increments
- ◆ Microstep dispense/aspirate resolution of 48,000 increments
- ◆ Y-Block, T-Valve, Straight-Valve, 3-Port Distribution, 4-Port Distribution, 6-Port Distribution, 8-Port Distribution, 10-Port Distribution, 12-Port Distribution, and 15-Port Distribution valves
- ◆ RS-232&RS-485 interface
- ◆ Programmable plunger speeds from 1.2 sec/stroke to 160 min/stroke, with ramps and on-the-fly speed changes
- ◆ Teflon coated lead screw drive with a quadrature encoder for lost-step detection
- ◆ Pump diagnostics, self-test, and error reporting
- ◆ Auxiliary inputs and outputs
- ◆ Operates using a single 24V DC power supply

1.2 Unpacking the SY03B

To unpack the module, follow these steps:

1. Remove the pump module(s) and accessories from the shipping cartons
2. Check the contents against the packing slip to make sure that all the components are present

1.3 ESD Considerations

SY03B is an electronic device that is sensitive to electrostatic discharge (ESD). Static discharge from clothing or other fixtures can damage these components. To prevent premature failure of pump components, use good ESD practices when handling the SY03B. These include, but are not limited to:

- ◆ Using wrist or ankle strap
- ◆ ESD mats or worktables
- ◆ ESD wax on the floor

1.4 Functional Description of the SY03B

SY03B uses a stepper-motor driven syringe and valve design to aspirate and dispense measured quantities of liquid. Both the syringe and the valve are replaceable. Functional descriptions and illustrations of each major SY03B component are provided in the following sections.

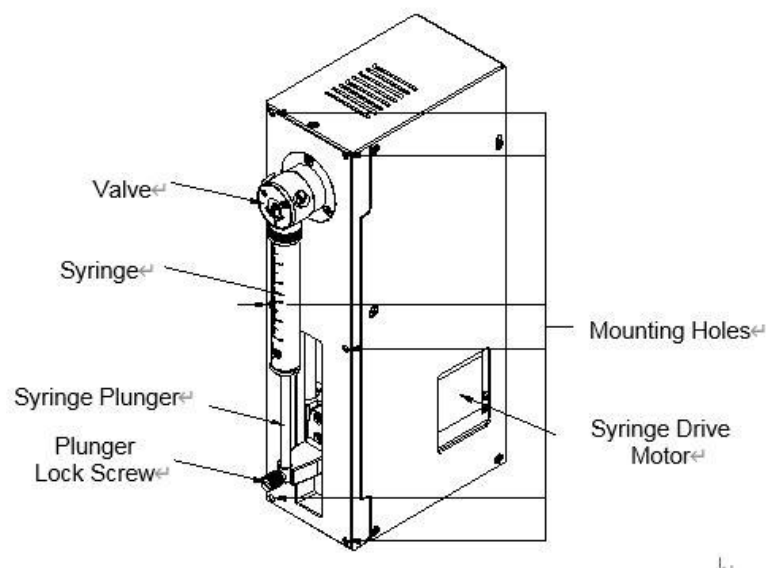

Figure1-1 SY-03B Syringe Pump

1.4.1 Syringe and Syringe Drive

The syringe plunger is moved within the syringe barrel by a lead screw drive that incorporates a 1.8° stepper motor and quadrature encoder to detect lost steps.

The syringe drive has a 60 mm travel length and resolution of 6,000 increments (48,000 increments in

fine-positioning and microstep mode). When power is not applied to the pump, the syringe drive can be removed by releasing the pin assembly.

The base of the syringe plunger is held to the drive by a knurled screw. The top of the syringe barrel attaches to the pump valve by a 1/4-28" fitting.

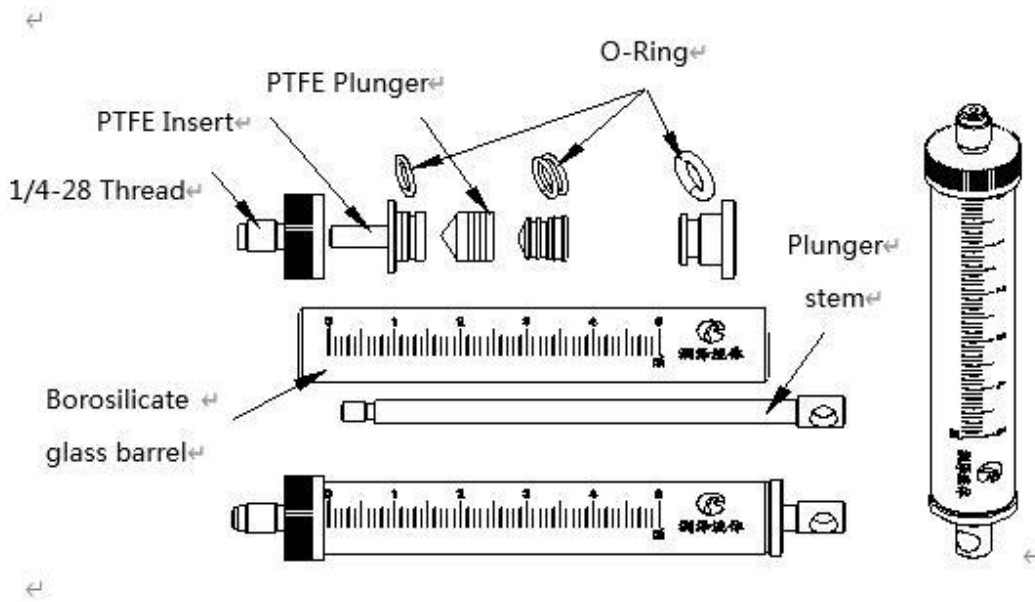

Figure1-2 Syringe Components

Syringes are available in these sizes: 25 μ l, 50 μ l, 100 μ l, 250 μ l, 500 μ l, 1ml, 1.25ml, 2.5ml, 5 ml、10ml & 25ml. If you need to order other sizes or other ordering information, please contact with our customer service.

1.4.2 Valve and Valve Drive

SY03B valves are available in one of two configurations: plug valves and face seal valves.

Plug Valves : The plug rotates inside the valve body to connect the syringe port to the various input and output ports. In addition to input and output ports, non-distribution valves also have a bypass position. This position “bypasses” the syringe and connects the input and output ports. The bypass position is often used for flushing fluid lines. Y-Valve,T-Valve,Two-way and 4-port distribution configurations are available in a plug valve design.

Face Seal Valves : The surface seal valve selects the input and output ports by adjusting the connector between the rotor and the stator.3-port distribution, 6-port distribution, 9-port distribution and 12-port distribution valve configurations are available in a face seal valve design

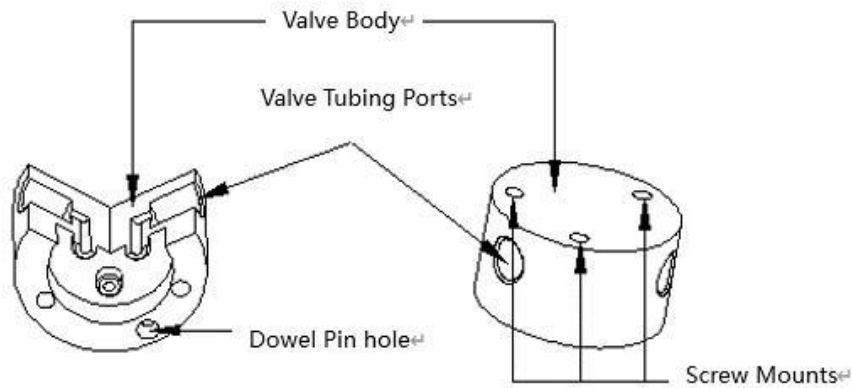

Figure 1-3 3-Port Valve Components (Plug Design)

1.4.3 Printed Circuit Assembly

The printed circuit assembly (PCA) holds the microprocessor and circuitry to control the syringe and valve drive. The PCA provides connectors for electrical inputs and outputs as well as a communication address switch. For information on modes of operation, see Chapter 3, "Software Communication". Figure 1-4 shows the accessible components on the printed circuit board assembly.

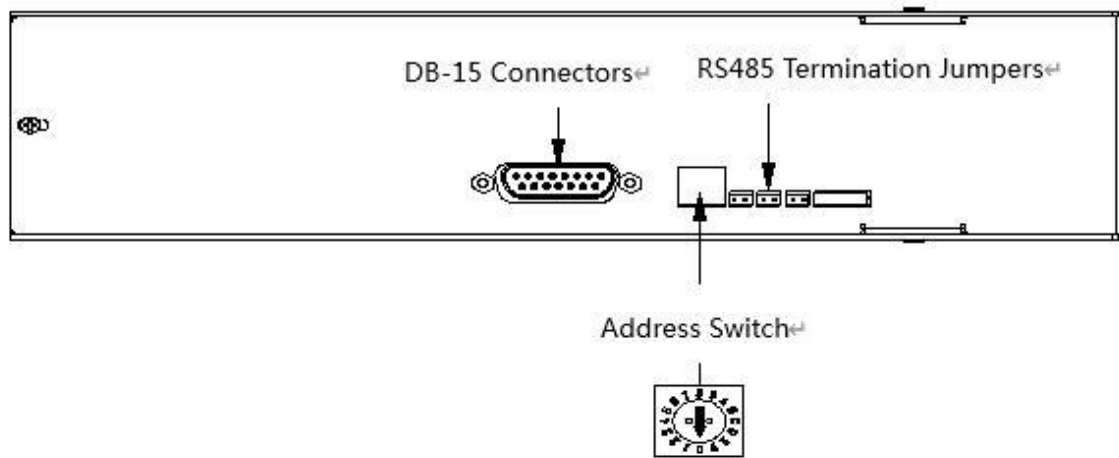

Figure 1-4 SY03B Printed Circuit Assembly External Connectors

SY03B PCA has a DB-15 connector to handle power and communications. For more information on the printed circuit assembly inputs/outputs and the address switch, see Chapter 2, "Hardware Setup".

1.4.4 Communication Interfaces

Depending on the pump configuration, the SY03B can communicate singly or in a multi-pump configuration through an RS-232 & RS-485 interface. For RS-232 and RS-485, baud rates of 9600 and 38400 are supported. For details on the communications interfaces, see Chapter 2, "Hardware Setup".

1.4.5 Multi-Pump Configurations

Up to fifteen (15) SY03B pumps can be connected together in a multi-pump configuration (also called “daisy-chaining”). In this configuration each pump is addressed separately from a single terminal via its unique address, which is set using the address switch on the back panel of the pump.

Within a multi-pump configuration, the RS-485 communications bus is required, although the first pump in the chain may receive either RS-232 or RS-485 communications.

For more information on setting addresses, see Chapter 2.

1.5 Safety

SY03B Syringe Pump is designed for pipetting and dispensing operations in the 25 μ L to 25 mL range. Any other use is considered improper and may result in damage to the pump and/or unreliable test results .

1.5.1 Notices and Symbols



Warning Notices Used in this Manual

The triangle warning symbol indicates the possibility of personal injury if the instructions are not followed

Specific symbols indicate the hazard to which a user is exposed. A few examples follow:



Toxic Substance

Chemical or biological hazards can be associated with the substances used or the samples processed with the SY03B. Always be aware of possible hazards associated with these substances.



Explosion and Fire Hazard

Never process explosive or highly flammable liquids with the SY03B.



Pinch Point, Mechanical Hazards

Automatically moving parts may cause injuries (crushing, piercing)



Attention

The general “Read This” symbol indicates the possibility of equipment damage, malfunction or incorrect process results, if instructions are not followed.

1.6 Tips for Setting Up the SY03B

For complete information on setting up the SY03B, see Chapter 2, "Hardware Setup" and "Chapter 3, "Software Communication".



Note: Risk to the user, property, and the environment can arise when the SY03B is used incorrectly. Before performing any work with the pump, first read the manual.

To ensure proper operation, follow these tips :

- ◆ Always set up and mount the pump in an upright position. Failure to do so can cause problems priming the system.
- ◆ Always run liquid through the syringe and valve when they are moving. Failure to do so can damage the sealing surfaces
- ◆ Always power down the instrument when connecting or disconnecting pumps.



Caution! Keep fingers out of the syringe slot while the pump is running. Failure to do so can cause injury

Chapter2 Hardware Setup

This chapter includes these sections describing the various parts of hardware setup :

- ◆ Power and Electrical Considerations
- ◆ Cabling
- ◆ Communication Interfaces
- ◆ Settings and Options
- ◆ Installing Components
- ◆ Mounting

2.1 Power and Electrical Considerations

SY03B requires a 24V DC power supply with a current rating of at least 1.5A, provided through a DB-15 connector. We recommends using one power cable for every two pumps to provide noise immunity, i.e., power should not be daisy-chained to more than two pumps.

2.1.1 Choosing a Power Supply

The 24V DC supply for a single SY03B should meet the following basic requirements :

- ◆ Output voltage: 24V nominal + 2%
- ◆ Well-regulated power supplies are recommended, as operating pumps below 24V will affect performance.
- ◆ Current rating of at least 1.5 A
- ◆ Conformance to required safety and EMI/RFI specifications
- ◆ Current should be limited to 35A or less

2.1.2 Integrating a Power Supply

When a power supply is used to operate more than one SY03B or other device, it must provide the total peak current for all devices. The power supply and filter capacitance together must satisfy the total peak input current for all devices.

If the pumps are not operating simultaneously then a reduced power supply rating may apply. The minimum power supply rating must be confirmed by measurement.

External equipment with inadequate bypass capacitance or that is inadequately sourced for current can cause overvoltage transients and sags, and can create unnecessary ripple current in the SY03B. This can result in decreased component life. Additionally, it is possible for a regulated power supply to become unstable with

certain loads and oscillate if adequate filter capacitance is not present. Some forms of oscillation can cause failures in the SY03B. These issues can be avoided by using a properly designed commercial power supply.

Consideration should also be given to the wiring of the SY03B and any additional devices. Wiring should be of sufficient gauge for the current, and as short as possible. Unless otherwise required by safety requirements, the power supply lines to the SY03B should be 20AWG or heavier. Multiple SY03B can be daisy-chained, provided that the wire size and the power supply are adequate for the total current. In the example of the six SY03B pumps above, use 18AWG wire if the units are daisy-chained. It is best if each pair is twisted or dressed together from the device to the supply. For more information on multi-pump cabling, see Section 2.2, Cabling.”

To control power to the SY03B, switch power to the power supply. Do not use a relay or switch contacts between the 24V supply and the SY03B (i.e. ,do not switch DC input to the pump).

2.1.3 Switching Power Supplies

Be sure to check carefully the minimum load requirement of the power supply. Typically, switching supplies have a minimum load requirement of up to 10% of the rated output current.

Note : SY03B idle current is less than 10% of the full running current.

For example, in a system with multiple SY03B pumps, a 24V 5-amp switcher with a minimum load less than 500mA may not provide sufficient current when the SY03B motors are idle and all other devices are in a low current state. If the SY03B is the only load on the 24V supply, a switcher should have a minimum load specification of 50mA or less. An appropriate external power resistor can be used to ensure that the minimum load is met.

2.2 Cabling

A single cable supplies both power and communications to each SY03B. A unique address identifies each pump module. For more information, see “Address Switch Settings” later in this chapter. See also Chapter 3, "Software Communication".

Power requirements are described in Section 2.1, Power and Electrical considerations

Pin	Function	Remarks
1	24v DC	
2	RS-232TxD Line	Output data
3	RS-232RxD Line	Input data
4	Reserved	

5	CAN high signal line	
6	CAN low signal line	
7	Auxiliary input #1	TTL level
8	Auxiliary input #2	TTL level
9	Ground	Power and logic
10	Ground	Power and logic
11	RS-485 A Line	Data+
12	RS-485 B Line	Data-
13	Auxiliary output #1	TTL level
14	Auxiliary output #2	TTL level
15	Auxiliary output #3	TTL level

Table 2-1 DB-15 Connector Pin Assignments

Figure 2-1 shows the pin positions of the DB-15 connector on the printed circuit assembly. This is a male connector that requires a female connector on the mating cable.

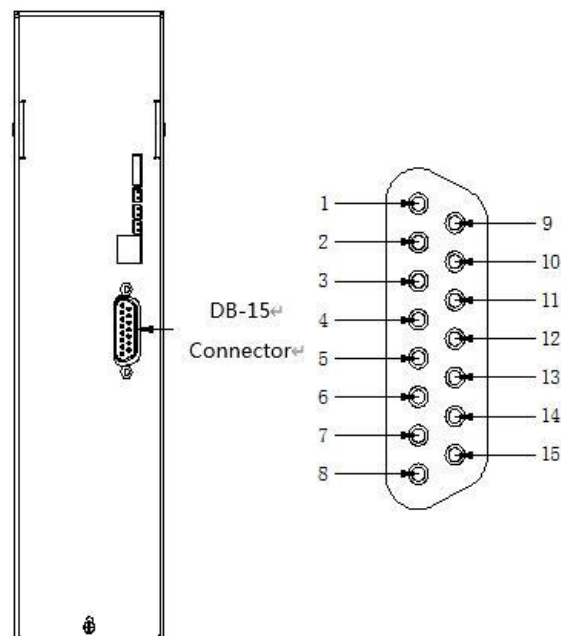

Figure 2-1 DB-15 Connector Pins

2.3 Communication Interfaces

The computer or controller communicates with the SY03B through an RS-232 interface, RS-485 interface. The SY03B automatically detects the communication interface.

Examples of cabling connections are shown in Figure 2-2, Figure 2-3 on the following pages.

2.3.1 RS232/RS485Interface

The RS-232 interface automatically converts the protocol to RS-485 for the benefit of any other devices which may be connected to the SY03B' s RS-485 communication bus (this constitutes the so-called “multi-drop” device configuration).

Note: The RS-232 interface does not support hardware handshaking and requires only three lines: RXD, TXD, and Signal Ground.

When using a multi-drop arrangement, up to 15 pumps can be addressed by the controller on the same communications bus. Take special care to ensure that the RS-485 A and B lines are not reversed. Refer to the cabling illustrations on the following pages. These illustrations show the multi-pump cabling for RS-232, RS-485 connections, respectively. Also shown is the external termination scheme for the RS-485 chain.

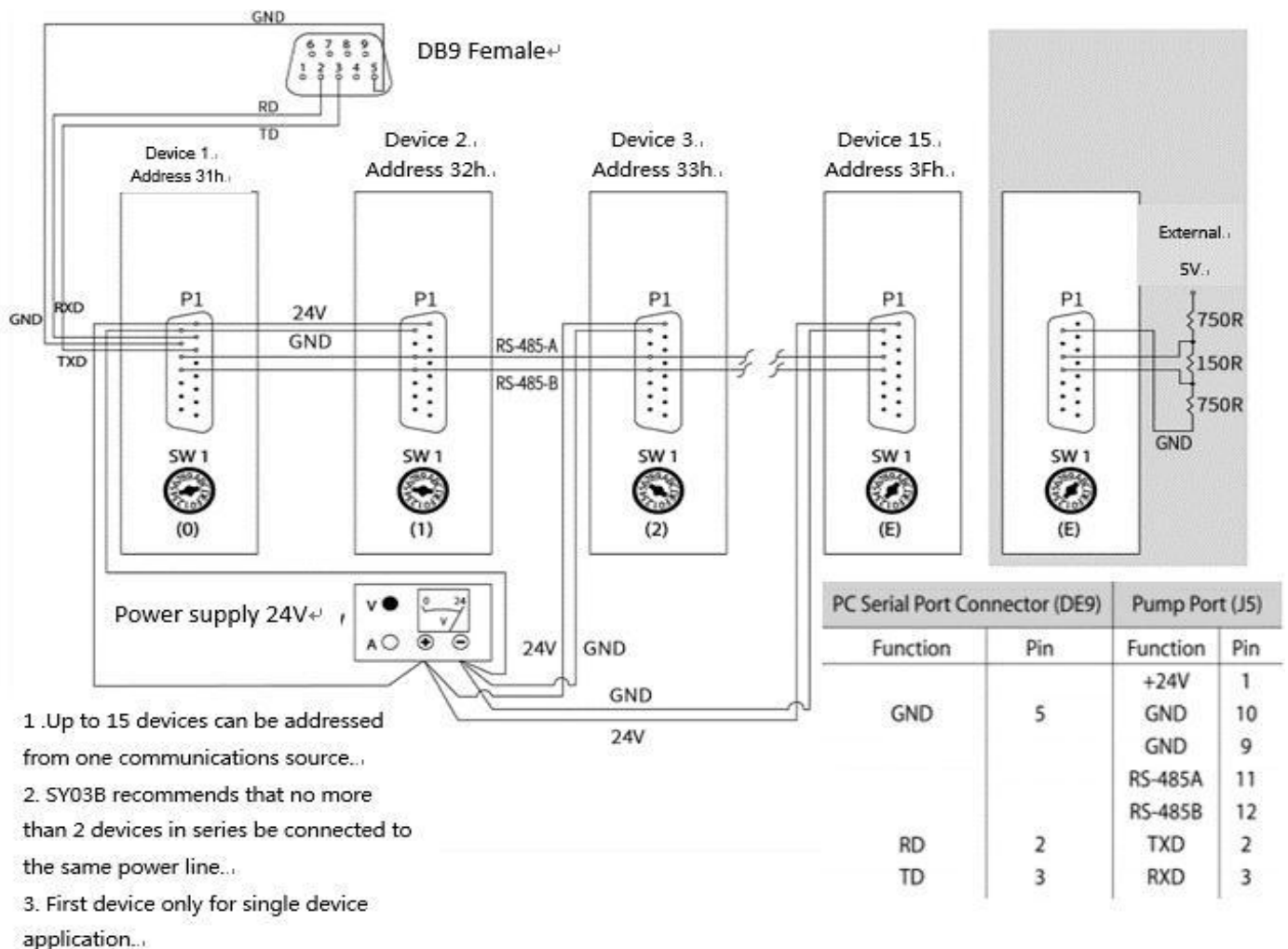

Figure 2-2 RS232 to RS485 Cabling

2.4 Settings and Options

2.4.1 Configuration Commands

SY03B firmware allows the user to configure the pump for different modes of operation. The U commands (see Chapter 3, "Software Communication") are used to write the configuration information to the non-volatile memory and control the following options:

Baud rate: RS-232/RS-485 communication is possible at 9600 baud (default) and 38400 baud.

Non-Volatile Memory Auto Mode: Allows the pump to run command strings out of the non-volatile memory.

Stall current: Allow the pump to set the corresponding reset stall current according to the size of the syringe.

2.4.2 Address Switch Settings

The address switch is located near the top of the SY03B electronic circuit board. It is used to give each SY03B in a multi-pump configuration a unique or specific address, allowing the user to direct commands to specific pumps. The address switch has sixteen positions (numbered 0 through F). Fifteen positions (addresses 0 through E) are valid pump addresses.

To set the address switch:

To set the address switch, use a jeweler's screwdriver or small flat head screwdriver and turn the switch in either direction to the desired position.

Note: *Power cycle (or power up) the pump after setting the address switch.*

For information on the addressing schemes for different pump configurations, see Chapter 3, "Software Communication".

2.4.3 Self-Test

The "F" address switch position is used to activate the SY03B self-test. Self-test causes the SY03B to initialize, then cycle repeatedly through a series of plunger movements. The self-test cycles through speed codes 5 to 40 (add 5 in turn). If an error condition occurs, the pump stops moving.

To run the self-test, set the address switch to position "F." Then supply power to the pump.

Caution! *Always run liquid through the syringe and valve. Failure to do so can damage the valve and syringe seal.*

2.4.4 P11 Inputs/Outputs

The SY03B provides two auxiliary inputs and three auxiliary outputs that can be accessed through the DB-15 connector, P11. They provide TTL level signals. The outputs are controlled by the [J] command.

The auxiliary inputs are located on P11, pins 7 and 8. They can be read back using report commands ?13 and ?14. Additionally, the inputs can be used to externally trigger a command sequence using the [H] command. The commands are described in Chapter 3, "Software Communication".

The auxiliary outputs are located on P11, pins 13, 14, and 15.

2.5 Installing Components

2.5.1 Installing the SY03B Valve

Users are not allowed to manually replace the SY03B valve head assembly. If you need to replace the valve head, please contact customer service.

2.5.2 Installing a Syringe

To install a syringe, follow these steps:

- 1 Remove the plunger lock screw.
- 2 Install the syringe as shown in Figure 2-3, following these steps:
 - a. Screw the syringe into the valve.
 - b. Pull the syringe plunger down to the plunger holder assembly.
 - c. Align the plunger button through hole to the carriage mounting hole.
 - d. Slide the plunger lock screw through the plunger button and fasten to the carriage.

Note: Make sure the plunger lock screw is securely tightened and the plunger button is free to move on the plunger lock screw.

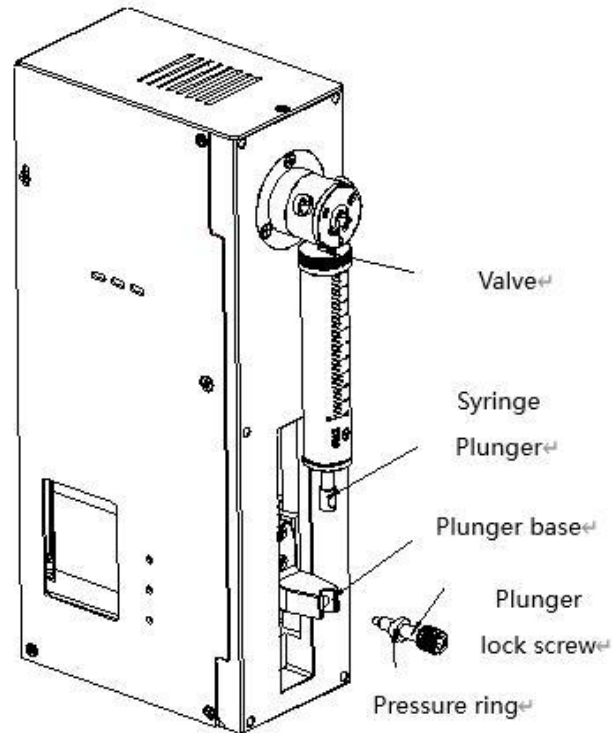

Figure 2-3 Syringe Installation

2.6 Mounting

SY03B contains six mounting holes on the front plate of the frame

Note: Always mount the pump in an upright position. Failure to do so can cause problems in priming the system.

To facilitate mounting, see Figure 2-4, "SY03B Outline Drawing" for critical dimensions and location of the mounting holes.

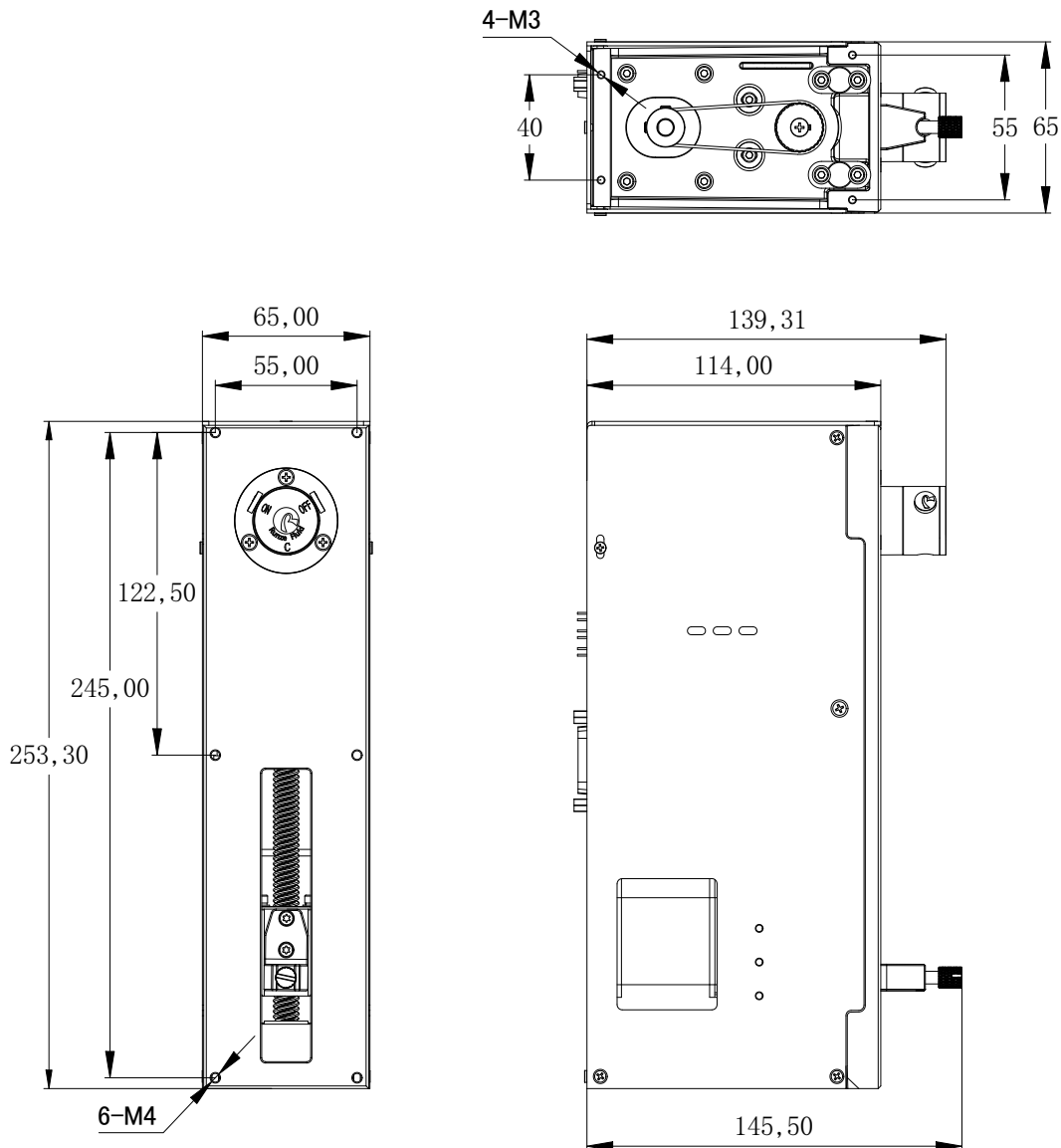

Figure 2-4 SY03B Outline Drawing

Chapter3 Software Communication

This chapter describes how to communicate with the SY03B: through an RS-232, RS-485 interface.

This chapter includes these topics:

- ◆ SY03B Addressing Scheme
- ◆ Communication Protocols
- ◆ Using the SY03B Command Set

- ◆ Initialization
- ◆ Operating Commands
- ◆ Error Codes and Pump Status

3.1 SY03B Addressing Scheme

As part of the communication protocol, an address for each pump must be specified. The user has the option of addressing a single pump, two pumps (dual device), four pumps (quad device), or all 15 pumps (all devices), depending on the address byte used. Each physical address in the address switch corresponds to a hexadecimal value, as shown in Table 3-1, Hexadecimal Addressing Scheme.

Address (hex)	Device
RS-232/RS-485	
30	Master Address (master controller, personal computer, etc.)
31...3F	Addresses single device
41...4F	Addresses two devices at a time (dual device)
51...5D	Addresses four devices at a time (quad device)
5F	Addresses all devices on the bus

Figure 3-1 Hexadecimal Addressing Scheme

For example, an SY03B with address switch set to 0 is addressed as device “31h” in the RS-232 or RS-485 communication protocol, hardware address 1 is addressed as device “32h,” and so on.

Table 3-2, Address Switch Settings in Hex (ASCII), shows the different address switch settings for each of these configurations

Note: When using the Pump: Link software to send commands to a device, use the ASCII address values in Table 3-2.

Switch Setting	Single Device		Dual Device		Quad Device		All Devices	
	Hex Address	ASCII Address	Hex Address	ASCII Address	Hex Address	ASCII Address	Address	Value to Send
0	31	1	41	A	51	Q	5F	-
1	32	2						
2	33	3	43	C	55	U	5F	-
3	34	4						
4	35	5	45	E	55	U	5F	-

5	36	6					
6	37	7	47	G	59	Y	
7	38	8					
8	39	9	49	I			
9	3A	:					
A	3B	;	4B	K			
B	3C	<					
C	3D	=	4D	M	5D]	
D	3E	>					
E	3F	?	4F	O			
F	Self Test						

Table 3-2 Address Switch Settings in Hex (ASCII)

The user can communicate with all pumps in the chain by using address “5Fh,” for example to initialize all pumps at once. Then each pump can be controlled independently by using addresses “31h” to “3Fh.”

Note: Multiple address commands cannot be used to determine device status or to request reports. Each device must be queried separately to gather status or generate a report..

3.2 Communication Protocols

Two communication protocols are available: :

OEM communication protocols

Data Terminal (DT) protocol

SY03B firmware automatically detects the communication protocol.

The DT protocol can be run via an ASCII data terminal because no sequence numbers or checksums are used. For instructions on using a Microsoft Windows Terminal Emulator, see “Using DT Protocol with Microsoft Windows” in this chapter.

Note: SY03B Systems recommends using the OEM protocol for RS-232 and RS-485 interfaces. It provides increased error checking through the use of checksums and sequence numbers.

Once the SY03B detects either the OEM or DT protocol, it will ignore the other protocol until the next power cycle.

3.2.1 OEM Communication Protocol

OEM communication is a robust protocol that includes automatic recovery from transmission errors.

Parameter	Setting
Character Format	
Baud rate	9600 or 38400
Data bits	8
Parity	None
Stop bit	1
Command Block (see "OEM Protocol Command Block Characters" for details)	
1	STX (^B or 02H)
2	Pump address
3	Sequence number
3+n	Data block (length n)
4+n	ETX (^C or 03H)
5+n	Checksum
Answer Block (see "OEM Protocol Answer Block Characters" for details)	
1	STX (^B or 02H)
2	Master address (0 or 30H)
3	Status code
3+n	Data block (length n)
4+n	ETX (^C or 03H)
5+n	Checksum

Table 3-3, OEM Protocol describes each setting within the OEM communication protocol.

OEM Protocol Command Block Characters

The command block characters in the OEM communication protocol are described below. All characters outside the command block are ignored.

When developing a parsing algorithm, the programmer should key on the STX as the beginning of the answer block and the checksum (character after the ETX) as the end of the answer block.

STX (^B or 02h)

The STX character indicates the beginning of a command

Pump Address

The pump address is a hexadecimal number specific for each pump

Sequence Number/Repeat Flag

The sequence number is a single byte that conveys both a sequence number (legal values: 0 to 7) and a bit-flag indicating that the command block is being repeated due to a communications breakdown. The

sequence number is used as an identity stamp for each command block. Since it is only necessary that every message carry a different sequence number from the previous message (except when repeated), the sequence number may be toggled between two different values (e.g., “1” and “2”) as each command block is constructed. During normal communication exchanges, the sequence number is ignored. If, however, the repeat flag is set, the pump compares the sequence number with that of the previously received command block to determine if the command should be executed or merely acknowledged without executing.

***Note:** If the operator chooses not to use this option, the sequence number can be set to a fixed value of 1 (31h).*

Data Block (length n)

The data block consists of the data or commands sent to the pump or host (this is an ASCII string). When the pump is responding to a move or [Q] command, the data block length is 0 (i.e., no data string exists).

ETX

The ETX character indicates the end of a command string.

Checksum

The checksum is the last byte of the message string. All bytes (excluding line synchronization and checksums) are XORed to form an 8-bit checksum. This is appended as the last character of the block. The receiver compares the transmitted value to the computed value. If the two values match, an error free transmission is assumed; otherwise, a transmission error is assumed.

OEM Protocol Answer Block Characters

The answer block characters in the OEM communication protocol are described below. Only the unique answer block entries are listed in this section. For common commands and answer block commands (characters), see the previous section, “OEM Protocol Command Block Characters.”

Master Address

The master address is the address of the host system. This should always be 30h (ASCII value “0”).

Status and Error Codes

The status and error codes define pump status and signal error conditions. For a description of status and error codes, see “Error Codes and Pump Status” .

3.2.2 Data Terminal (DT) Protocol

The DT protocol can be used easily from any terminal or terminal emulator capable of generating ASCII characters at 9600 baud, 8 bits, and no parity.

Character Format	
Parameter	Setting
Baud rate	9600 or 38400
Data bits	8
Parity	None
Stop bit	1
Command Block (see “DT Protocol Command Block Characters” for details)	
1	Start command (ASCII “/” or 2FH)
2	Pump address
2+n	Data block (length n)
3+n	Carriage Return ([CR] or 0DH)
Answer Block (see “DT Protocol Answer Block Characters” for details)	
1	Start answer (ASCII “/” or 2FH)
2	Master address (ASCII “0” or 30H)
3	Status character
3+n	Data block (length n)
4+n	ETX (03H)
5+n	Carriage return (0DH)
6+n	Line feed (0AH)

Table 3-4 DT Protocol

DT Protocol Command Block Characters

The command block characters in the DT communication protocol are described below:

Start Block

The start character indicates the beginning of a message block.

Pump Address

The pump address is an ASCII character specific to each pump.

Data Block (length n)

The data block consists of the ASCII data or commands sent to the pump or host.

End Block

The end character indicates the end of a message block.

DT Protocol Answer Block Characters

The answer block characters comprising the DT communication protocol are described below.

Only unique answer block entries are listed in this section. For information on command and answer block commands (characters), see the previous section, “OEM Protocol Command Block Characters.”

Master Address

The master address is the address of the host system. This should always be 30h (ASCII “0”).

Status Character

The status and error codes define pump status and signal error conditions. See the description of the [Q] command in “Error Codes and Pump Status.”

Data Block

This is the response from all Report commands with the exception of the [Q] command.

Carriage Return (0dh)/Line Feed (0AH to 0CH)

This character terminates the reply block

3.2.3 Using DT Protocol with Microsoft Windows

The SY03B can be controlled in DT protocol mode directly from the Microsoft Windows terminal accessory.

To communicate with the SY03B using Windows , follow these steps:

- 1 Connect the SY03B to a communications port of the PC.
- 2 From the Microsoft Program Manager window, start the SerialCommV1.0 application.
- 3 Select more serial port Settings.
- 4 Select a baud rate of 9600, 8 data bits, 1 stop bit, no parity, communications port connector (for example,COM1), and no flow control.
- 5 Click OK and click again to start the serial port
- 6 Set the pump address switch to 0.
- 7 Power on the pump.
- 8 Type /1ZR to initialize the pump.
- 9 To run the pump, see the commands listed in “Using the SY03B Command Set” in this chapter.

3.3 Using the SY03B Command Set

3.3.1 Command Execution Guidelines

To use the commands properly, keep the following in mind:

- ◆ All commands, except Report commands and most Control commands, must be followed by an [R] (Execute) command
- ◆ Single or multiple command strings can be sent to the pump.

For example:

- A single command such as [A6000R] moves the plunger to position 6000.
- A multi-command string such as [IA6000OA0R] moves the valve to the input position, moves the plunger to position 6000, turns the valve to the output position, and finally returns the plunger to position 0.
- ◆ The pump's command buffer holds a maximum of 255 characters. If a command is sent without the [R] (Execution) command, it is placed into the buffer without being executed. If a second command is sent before the first command is executed, the second command overwrites the first command (i.e., the first command string is erased).
- ◆ Once a command is executed, new commands are not accepted until the sequence is completed. Exceptions to this rule include interruptible (see "T Terminate Command" in this chapter) and Report commands.
- ◆ When a command is sent, the pump answers immediately. If an invalid command has been sent in a command string, or there was an invalid parameter in the command, the pump reports an error immediately. In the case of a [Q] (Query) command, the error is read back to the host computer.
- ◆ Always run liquid through the syringe and valve when issuing a Move command. Failure to do so may damage the valve and syringe seal.
- ◆ Keep fingers out of the syringe slot while the pump is running. Failure to do so can result in injury.

3.3.2 Pump Configuration Commands

SY03B pumps are preconfigured at the factory to the default settings. The firmware, however, allows the user to configure the pump to meet his or her specific requirements. Configuration options available to the user include resolution, backlash, valve type, and baud rate.

N <n> Set Microstep Mode Off/On

The [N] command enables or disables microstepping (fine positioning).

The syntax for this command is:

[N<n>]

where <n> = 0 or 1 (0 is the default)

Value of <n>	Description
0	Normal mode: All positions set and reported in half-steps; all speedsettings in half-steps/sec and all slopes in half-steps/sec 2.

1	Fine positioning mode: All positions set and reported in micro-steps; all speed settings in half-steps/sec and all slopes in half-steps/sec 2 . Maximum cutoff frequency limited to 750 half-steps/sec; maximum on- the-fly set velocity limited to 750 half-steps/sec.。
2	Micro-step mode: All positions set and reported in micro-steps; all speed settings in micro-steps/sec and all slopes in micro-steps/sec 2 .

K<n> Backlash Increments

The [K] command sets the number of backlash increments.

The syntax for this command is

[K<n>]

where <n> = 0---800 in full step mode (12 is the default),

and <n> = 0---6400 in fine positioning mode (96 is the default).

When the syringe drive motor reverses direction, the carriage will not move until the backlash due to mechanical play within the system is compensated. To provide this compensation, during aspirating, the plunger moves down additional increments, then backs up the set number of backlash increments.

This ensures that the plunger is in the correct position to begin a dispense move.

> Set User Data Command

The [>] command loads a byte of user data into non-volatile memory:

[> <n1>, <n2>], where: <n1> is 0..15 (location in non-volatile memory) and

<n2> is 0..255 (data to load into non-volatile memory).

U<n> Write Pump Configuration to Non-Volatile Memory

The [U] command is used to write configuration information to the non-volatile memory. The pumps are configured during the manufacturing process but can be reconfigured at any time with the following [U] commands

Value<n>	Description
30	Set Non-Volatile Memory Auto Mode
31	Clear Non-Volatile Memory Auto Mode
41	Set RS-232/RS-485 Baud rate to 9600
47	Set RS-232/RS-485 Baud rate to 38400

Figure 3-5 Write Pump Configuration Command Values

Note: [U] commands take effect upon the pump's next power-up.

3.4 Initialization

3.4.1 Initialization Forces

Initialization moves the plunger to the top of travel, then backs off a user-specified number of increments (see k command) and sets this as position 0. Also, the input and output positions of the valve are assigned depending on the initialization command. All other command parameters are reset to default values.

The top of the syringe is recognized when upward movement of the plunger causes an overload condition.

The force at which the plunger presses against the top of the syringe can be controlled via a parameter after the Initialization command (possible values are 0, 1 and 2).

Table 3-6 lists the recommended initialization force for each type of syringe.



Caution! To retain the integrity of the seal on smaller syringes, use a lower initialization force than that for larger syringes. The default initialization speed is 500 Hz.

Syringes	Force
1.0 mL and larger	Full
250, 500 μ l	Half
50, 100 μ l	Third

Figure 3-6 Recommended Initialization Forces by Syringe

k <n> Syringe Dead Volume Command / Offset Steps after Reset

The [k] command sets the number of increments that the plunger drive is offset from the top of travel. This is to minimize dead volume.

The syntax for this command is:

[k<n>]

where:

n = the offset in increments from top of travel

n = 0..800

n = 0..6400 in fine positioning and microstep modes

Under default initializations, the plunger moves upward until it contacts the top of the syringe, causing a forced stall initialization. The plunger then moves downward and upward, leaving a small gap between the syringe seal and the top of the plunger. This small gap was designed so that the Teflon seal does not hit the top of the plunger each time the syringe moves to the “home” position. This maximizes the life of the syringe

seal.

The [k] command must be followed by the Initialization command [Z], [Y], or[W]. Each time the unit is powered down, the “k” value will return to the default condition.

For example, to offset 10 increments away from the top of travel, send the following commands:

- k10R
- ZR

3.4.2 Initialization Commands

Z <n1, n2, n3> Initialize Plunger and Valve Drive (CW Polarity)

The [Z] command initializes the plunger drive and homes the valve in a clockwise direction. Valve ports are numbered 1..X, starting in a clockwise direction at the first port after the syringe port. The default initialization speed is 500 pulses per second.(In the SY03B system, the process of suction is initialized in input port, and the dispensing is initialized in output port)

n 1 = Set initialization plunger force/speed

n 2 = Set initialization input port

n 3 = Set initialization output port

The parameters are described below:

Z Parameter	Value	Description
<n1>	0	Initializes at full plunger force and at default initialization speed (default)
	1	Initializes at half plunger force and at default initialization speed
	2	Initializes at one-third plunger force and at default initialization speed
	10..40	Initializes at full force and at speed code <n 1 >. See command <S> for a list of speed codes.
<n2>	0	Sets initialization input port to port 1 (default)
	1..X	Sets initialization input port for distribution valves, where X is the number of ports on the valve.
<n3>	0	Sets initialization output port to port X (default), where X is the number of ports on the valve.
	1..X	Sets initialization output port for distribution valves, where X is the number of ports on the valve.

Y<n1、n2、n3 > Initialize Plunger and Valve Drive (CCW Polarity)

The [Y] command initializes the plunger drive and homes the valve in a counter-clockwise direction. Valve ports are numbered 1..X in a counter-clockwise direction starting with the first port after the syringe port. The default initialization speed is 500 pulses per second.

n 1 = Set initialization plunger force/speed

n 2 = Set initialization input port

n 3 = Set initialization output port

The parameters are described below.

Y Parameter	Value	Description
<n1>	0	Initializes at full plunger force and at default initialization speed (default)
	1	Initializes at half plunger force and at default initialization speed
	2	Initializes at one-third plunger force and at default initialization speed
	10...40	Initializes at full force and at speed code <n 1 >. See command <S> for a list of speed codes.
<n2>	0	Sets initialization input port to port 1 (default)
	1...X	Sets initialization input port for distribution valves, where X is the number of ports on the valve.
<n3>	0	Sets initialization output port to port X (default), where X is the number of ports on the valve.
	1...X	Sets initialization output port for distribution valves, where X is the number of ports on the valve.

W <n1> Initialize Plunger Drive

The [W] command initializes the plunger drive only (commonly used for valveless pumps). Because the valve is not initialized, only plunger force and/or speed can be set. The default initialization speed is 500 pulses per second.

n 1 = Set initialization plunger force/speed

The parameters are described below.

W Parameter	Value	Description
<n1>	0	Initializes at full plunger force and at default initialization speed (default)
	1	Initializes at half plunger force and at default initialization speed
	2	Initializes at one-third plunger force and at default initialization speed.
	10...40	Initializes at full force and at speed code <n 1 >. See command <S> for a list of speed codes.

w<n1, n2> Initialize Valve Drive

The [w] command initializes the valve drive only. Because the plunger is not initialized, only the initialization port can be set.

n 1 = Set port

n 2 = Set valve homing and port numbering direction

The parameters are described below.

w Parameter	value	Description
<n1>	1...X	Set initialization port, where X is the number of ports on the valve

<n2>	0	Valve homes in a <i>clockwise</i> direction; valve ports numbered in a <i>clockwise</i> direction.
	1	Valve homes in a <i>counterclockwise</i> direction; valve ports numbered in a <i>counterclockwise</i> direction.

z Simulated Plunger Initialization

The [z] command simulates an initialization of the plunger drive, however, no mechanical initialization occurs. The current position of the plunger is set as the zero (home) position.

This command can be used after a plunger overload error, to regain control of the pump. After recovering from the overload condition using the [z] command, the pump must be reinitialized using the Z<n 1 , n 2 , n 3 > or Y<n 1 , n 2 , n 3 > commands to set the true home position.

Caution! *Incorrect use of this command can damage the device.*

3.5 Operating Commands

3.5.1 Valve Commands

Valve commands position the input and output channels to the specified ports. Similar valve commands cause different actions depending on whether you are using non-distribution valves or distribution valves.

With non-distribution valves, any combination of two valve ports, including or excluding the syringe port, may be used. With distribution valves, the syringe port is a common port, always included as one of the two valve ports in use.

The initialization command (Z, Y, or w) determines:

the direction in which the valve homes during initialization (clockwise or counterclockwise)

the direction in which the ports are numbered, starting with the syringe port (clockwise or counterclockwise)

After initialization, the direction in which the valve moves is specific to the valve type and command.

With non-distribution valves, the I, O, B, or E command specifies the combination of valve ports to be connected. The valve moves following the shortest path available.

For example, in Figure 3-2, if the 3-port non-distribution valve has been initialized with the [Z] command, the ports will be numbered as shown in the top diagram (clockwise). Issuing an [O] command aligns the syringe port with port 2, as shown.

Figure 3-2 Valve Position Examples for 3-Port Non-Distribution Valves

3-Port Valve

Z Initialization Command Examples
 Port sequence is clockwise from Syringe port (C)

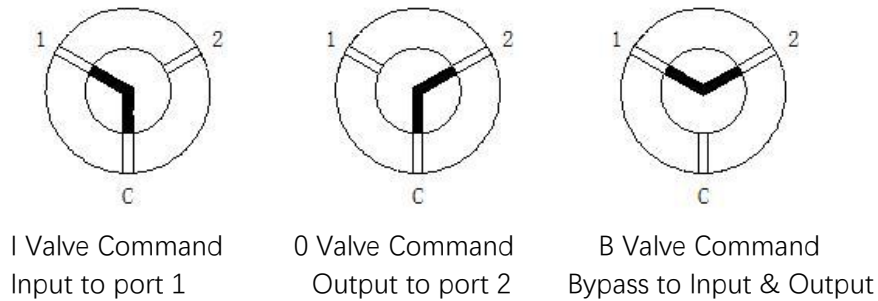

With distribution valves, the direction in which the valve moves is determined by the valve command. It will not necessarily follow the shortest path.

- The [I] command moves the valve in a clockwise direction.
- The [O] command moves the valve in a counterclockwise direction.

Note: Use of [I] and [O] in distribution valves is by convention, and does not pertain to input or output characteristics

Because the syringe port is always a common port, in distribution valves, the [B] (Bypass) and [E] (Extra) commands are meaningless. However, the commands are available, to provide backward compatibility with earlier versions of firmware.

For example, in Figure 3-3, if the 3-port distribution valve has been initialized with the [Y] command, the ports will be numbered as shown in the bottom diagram (counterclockwise). Issuing an [O<3>] command will align the syringe port with port 3, as shown.

Figure3-3 Valve Position Examples for 3-Port Distribution Valves

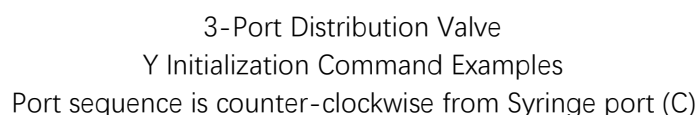
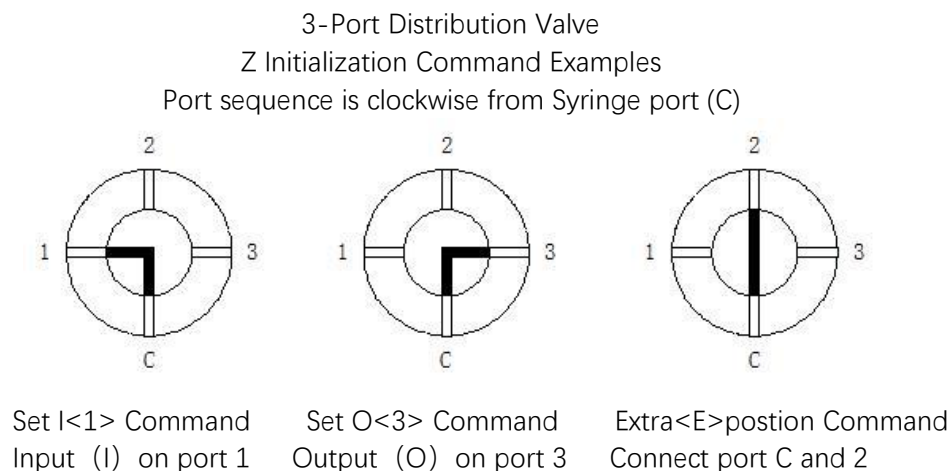

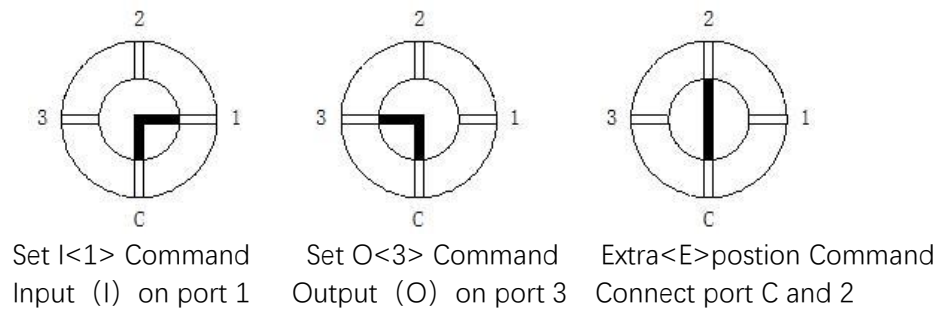

Following are more detailed descriptions of the various valve commands and what they do.

I Move Valve to Input Position (Non-distribution Valves)

The [I] command moves the valve to the input port set by the initialization command, following the shortest path.

I < n > Move Valve Clockwise to Port n (Distribution Valves)

The [I<n>] command sets the valve position to port [n], moving in a clockwise direction. This command is independent of input or output characteristics.

O Move Valve to Output Position (Non-distribution Valves)

The [O] command moves the valve to the output port set by the initialization command, following the shortest path.

O < n > Move Valve Counterclockwise to Port n (Distribution Valves)

The [O<n>] command sets the valve position to port [n], moving in a counter-clockwise direction. This command is independent of input or output characteristics.

B Move Valve to Bypass (Non-distribution Valves)

The [B] command connects the input and output positions, bypassing the syringe. The valve moves following the shortest path.

E Move Valve to Extra Position (4-Port Non-distribution Valve)

The [E] command connects the extra position in the 4-port valve, bypassing the syringe. The valve moves following the shortest path.

Note: The [B] and [E] commands are useful when flushing fluid lines. If a Valve command is issued to a valveless pump, the command is ignored.

Caution! When the valve is in the Bypass position, the syringe plunger will not move. Sending a Plunger Movement command causes an error 11 (plunger move not allowed)

Figure3-4 Valve Position Examples for 4-Port Non-Distribution Valves

4 Port-Valve

Z Initialization Command Examples

Port sequence is clockwise from Syringe(C) Port

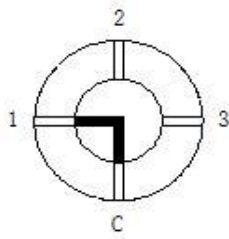

Sets I command
Input (I) on port 1

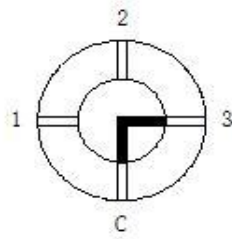

Sets 0 command
Output (O) on port 3

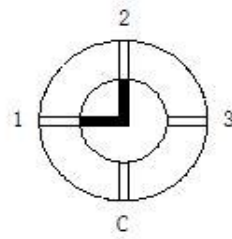

Bypass(B)command
Connects ports 1 & 2

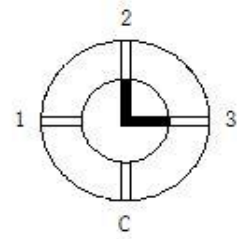

Extral(E)position command
Connects ports 2 & 3

4 Port-Valve

Y Initialization Command Examples

Port sequence is counter-clockwise from Syringe(C) Port

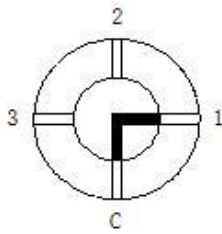

Sets I command
Input (I) on port 1

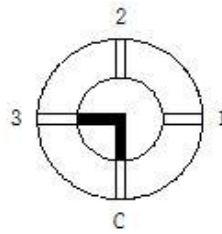

Sets 0 command
Output (O) on port 3

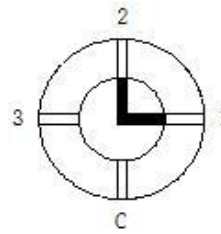

Bypass(B)command
connects ports 1 & 2

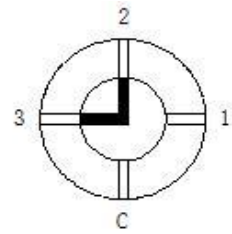

Extral(E)position command
connects ports 2 & 3

Figure 3-5 Valve Position Examples for T Valves (Distribution)

T-Valve

Z Initialization Command Examples

Port sequence is clockwise from Syringe (C) port

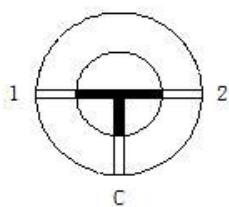

Sets I command
Input(I)on port1&2

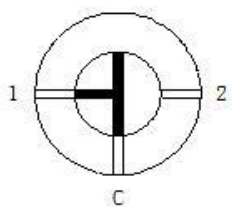

Bypass(B)command
connects port1

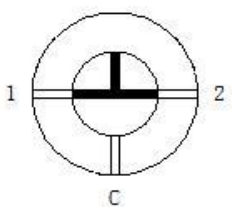

Extral(E)command
connects port1&2

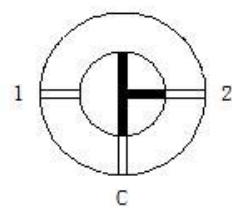

Sets 0 command
Output(O)on port 2

T-Valve

Y Initialization Command Examples

Port sequence is counter-clockwise from Syringe (C) port

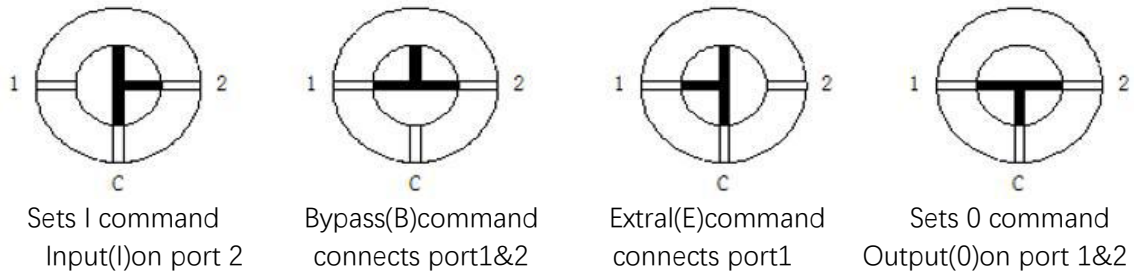

Note: For M02 T-type valve head, it is forbidden to use the piston movement command ([A], [a], [P], [p], [D], [d]) to move the piston when the valve head is switched to I3!!(Pay attention)

Figure3-6 Valve Position Examples for 6-Port Distribution Valves

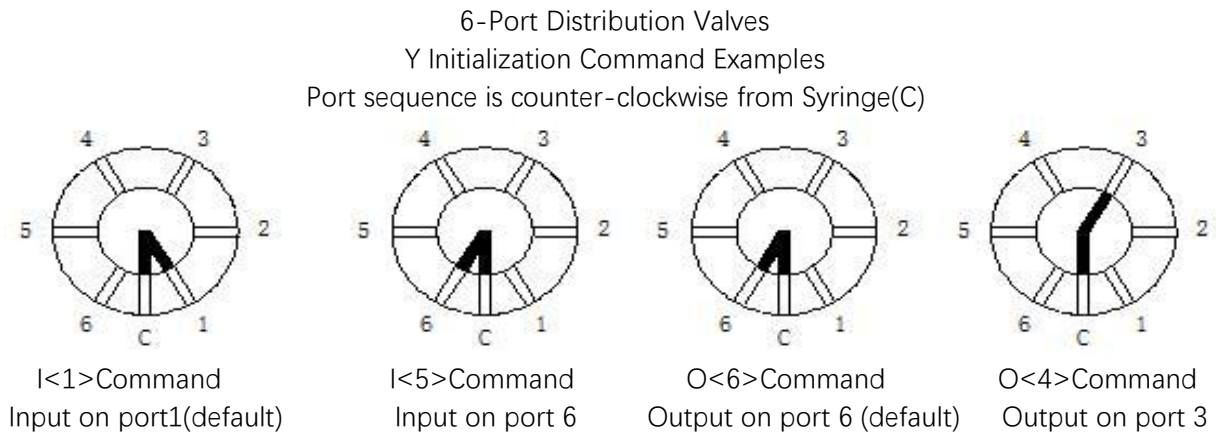
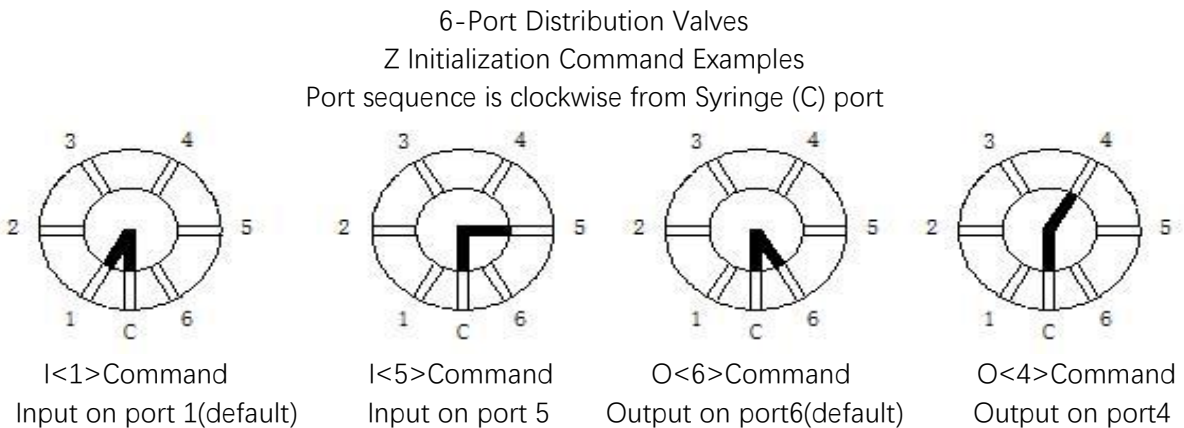
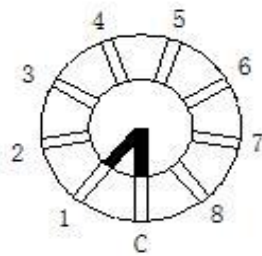
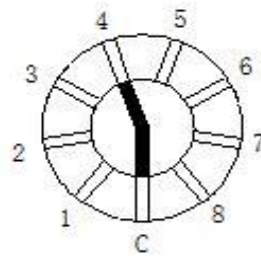

Figure3-7 Valve Position Examples for 8-Port Distribution Valves

8-Port Distribution Valves
Z Initialization Command Examples
Port sequence is clockwise from Syringe (C) port



I<1>Command
Input on port 1(default)



I<4>Command
Input on port 4

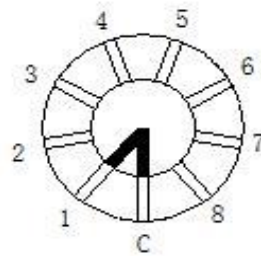

O<1>Command
Output on port1(default)

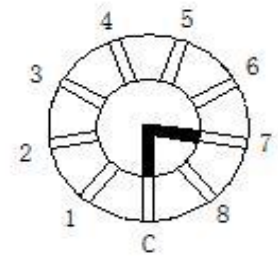

O<7>Command
Output on port

8-Port Distribution Valves
Y Initialization Command Examples
Port sequence is counter-clockwise from Syringe (C)

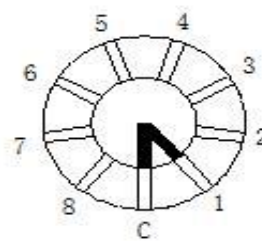

I<1>Command
Input on port 1(default)

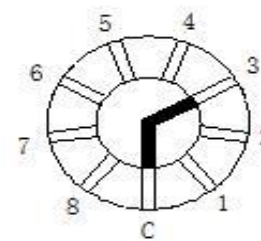

I<3>Command
Input on port 3

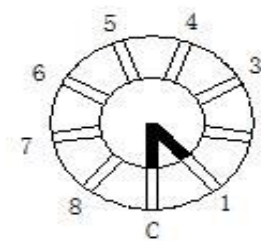

O<1>Command
Output on port1(default)

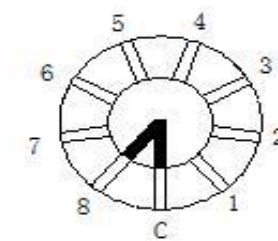

O<8>Command
Output on port8

3.5.2 Plunger Movement Commands

A <n> Absolute Position

The [A] command moves the plunger to the absolute position <n>, where <n> = 0..6000 in standard mode and 0..48000 in fine positioning and microstep mode.

Command	<n> Parameter Value	Description
A	0-6000	Absolute position in half increments (N=0)
	0-48000	Absolute position in microsteps (N=1)
	0-48000	Absolute position in microsteps (N=2)

For example:

- [A300] moves the syringe plunger to position 300.
- [A6000] moves the syringe plunger to position 6000.

a <n> Absolute Position (Not Busy)

This is the same as the [A] command, except that the status bit within the reply string indicates that the pump is not busy.

P <n> Relative Pickup

The [P] command moves the plunger down the number of increments commanded. The new absolute

position is the previous position plus <n>, where

<n> = 0.6000 in standard mode and

<n> = 0.48000 in fine positioning and microstep mode.

Command	<n> Parameter Value	Description
P	0-6000	Relative position in half increments (N=0)
	0-48000	Relative position in microsteps (N=1)
	0-48000	Relative position in microsteps (N=2)

For example:

The syringe plunger is at position 0. [P300] moves the plunger down 300 increments. [P600] moves the plunger down an additional 600 increments to an absolute position of 900.

The [P] command will return error 3 (invalid operand) if the final plunger position is greater than 6000.

p <n> Relative Pickup (Not Busy)

This is the same as the [P] command, except that the status bit of the reply string indicates that the pump is not busy..

D <n> / d <n> Relative Dispense

The [D] command moves the plunger upward the number of increments commanded. The new absolute position is the previous position minus <n>,where

<n> = 0.6000 in standard mode and

<n> = 0.48000 in fine positioning and microstep mode.

Command	<n> Parameter Value	Description
D	0-6000	Relative position in half increments (N=0)
	0-48000	Relative position in microsteps (N=1)
	0-48000	Relative position in microsteps (N=2)

For example:

The syringe plunger is at position 3000. [D300] will move the plunger up 300 increments to an absolute position of 2700.

The [D] command will return error 3 (invalid operand) if the final plunger position would be less than 0.

d <n> Relative Dispense (Not Busy)

This is the same as the [D] command, except that the status bit of the reply string indicates that the pump is not busy.

3.5.3 Set Commands (Speed and Acceleration)

Set commands are used to control the speed of the plunger. Plunger movement is divided into three

phases:

- **Ramping Up.** Plunger movement begins with the start speed and accelerates with the programmed slope to the constant or top speed.
- **Constant or Top Speed.** The plunger moves at the constant or top speed. Plunger speed can be programmed in Hz (half-increments/second) or in preprogrammed Set Speeds. The actual time the plunger travels is dependent on the ramping up and down. If the plunger move is short, it may never reach top speed.
- **Ramping Down.** The plunger will decelerate based on the programmed slope. To enhance fluid breakoff, the Cutoff command ([c]) can be used to define the end speed of the plunger just before it stops.

***Note:** The Cutoff command is only active in a dispense move. During aspiration the move will end at the start speed [v].*

For each plunger move, the firmware calculates how many increments the plunger must travel during each phase in order to move the total number of increments commanded. If the plunger is moving at a rate less than 900 Hz, the pump automatically microsteps to reduce the pulsation.

The top speed can be changed on the fly (while the plunger is moving) using the [v] command, providing the top speed is less than or equal to the start speed. Ramps are not included in on-the-fly speed changes; therefore, large speed changes (100 Hz to 1000 Hz) are not recommended.

***Note:** Unless the top speed is less than or equal to the start or cutoff speed, always program the pump in order of the move: start speed [v], top speed [V], cutoff speed [c].*

Changing Speed on the Fly

Speed changes can be made while the syringe plunger is moving. This is called “changing speed on the fly.”

Speeds can be decreased or increased between 5 and 12000Hz (i.e., in the fine positioning region)

To change speed on the fly:

1. Issue speed commands with identical start and top speeds (e.g., [v100V100]), followed by a Plunger Move command. Ramping is not allowed in on-the-fly changes.
2. Issue a new top speed in the range 5 to 750 (e.g. [V600]) while the plunger is moving, to change the speed on the fly.

***Note:** When the move completes, speed values revert to original values (i.e., value sent on-the-fly is temporary).*

L <n> Set Slope

During the beginning and end of a move, the plunger speed ramps up and down respectively. The ramp is programmed using the Slope command. It is calculated as $\langle n \rangle \times 2.5 \text{ pulses/sec}^2$. The syntax for this command is:

[L<n>]

where $\langle n \rangle = 1..20$ (14 is the default)

In normal or fine positioning modes (N0, N1) pulses are in half steps. In micro-step mode (N2) pulses are in micro-steps.

The corresponding slopes in pulses/sec² are listed below.

Slope Code	Pulses/sec ² (KHz)
1	2500
2	5000
3	7500
4	10000
5	12500
6	15000
7	17500
8	20000
9	22500
10	25000
11	27500
12	30000
13	32500
14	35000
15	37500
16	40000
17	42500
18	45000
19	47500
20	50000

v <n> Set Start Speed

The [v] command sets the speed at which the plunger begins its movement, in pulses/sec. The plunger will then ramp up (slope) to the top speed. The start speed should always be less than the top speed

Command	<n> Parameter Value	Default Value	Description
v	1-1000	900	Set start speed in pulses/sec.

V <n> Set Top Speed

The [V] command sets the top speed in pulses/second. This command may be sent while a command string is already executing. (See section on Changing Speed on the Fly, earlier in this chapter.)

Command	<n> Parameter Value	Default Value	Description
V	1-6000	1400	Set top speed in pulses/sec.

Note: According to the different specifications of the syringe, the value can be adjusted to 12000, but we can only guarantee that 1-6000 will run perfectly on the syringe we provide. For the speed set higher than V6000, Users must determine the appropriate speeds for their actual applications.

S <n> Set Speed

The [S] command sets a predefined top plunger speed, in pulses/sec. As <n> increases, the plunger speed decreases.

Command	<n> Parameter Value	Default Value	Description
S	0-40	11	Set plunger drive speed in pulses/sec.

These speed settings do not cover the full range of speeds the plunger can travel. They are commonly used speeds provided for the convenience of the user. All times are approximate and will vary with different ramp speeds and cutoffs. For information on determining timing for specific applications, see Appendix B, "Plunger Information".

The [S] command sets top speed without changing start speed, slope, and cutoff speed, except under the following conditions:

- If the start speed is higher than the (new) top speed, start speed is changed to equal the top speed.
- If the cutoff speed is higher than the (new) top speed, cutoff speed is changed to equal the top speed.

Speed codes, the Hz (pulses/second) equivalent, and seconds per stroke are listed below. Seconds/stroke values are based on default ramping

Speed Code	Value (pulses/sec)	Seconds/stroke (N=0, N=1)	Seconds/stroke (N=2)
0	6000	1.25	8.25
1	5600	1.30	8.80
2	5000	1.39	9.79
3	4400	1.52	11.1
4	3800	1.71	12.8
5	3200	1.97	15.1
6	2600	2.37	18.5
7	2200	2.77	21.9
8	2000	3.03	24.0
9	1800	3.36	26.7

10	1600	3.77	30.0
11	1400	4.30	34.3
12	1200	5.00	40.0
13	1000	6.00	48.0
14	800	7.50	60.0
15	600	10.00	80.0
16	400	15.00	120
17	200	30.00	240
18	190	31.58	253
19	180	33.33	267
20	170	35.29	282
21	160	37.50	300
22	150	40.00	320
23	140	42.86	343
24	130	46.15	369
25	120	50.00	400
26	110	54.55	436
27	100	60.00	480
28	90	66.67	533
29	80	75.00	600
30	70	85.71	686
31	60	100.00	800
32	50	120.00	960
33	40	150.00	1200
34	30	200.00	1600
35	20	300.00	2400
36	18	333.33	2667
37	16	375.00	3000
38	14	428.00	3429
39	12	500.00	4000
40	10	600.00	4800

Note: To achieve maximum stroke time of 100 minutes for N=0, N=1 or 800 minutes for N=2, At this time, the [S] speed code is not available, and the [V1] instruction is required for programming.

c <n> Cutoff Speed in Pulses/Second

The [c] command sets the speed at which the plunger ends its movement, in pulses/sec. The plunger will ramp down (slope) from the peak speed. The [c] command overwrites the [C] command.

Command	<n> Parameter Value	Default Value	Description
c	1-5400	900	Set cutoff speed in half-steps/sec (N=0,N=1)
	1-1500	900	Set cutoff speed in micro-steps/sec (N=2)

Note: [c] is only valid in a dispense move. During aspiration, [c] = [v]

3.5.4 Interaction of Set Commands

The Start Speed [v], Top Speed [V], and Cutoff Speed [c] commands interact according to the following rules:

$$[v] \leq [c] \leq [V]$$

1. Start Speed should always be less than or equal to Top Speed. Changing the Start Speed will change the Cutoff Speed if Cutoff Speed is less than the Start Speed set. If the Start Speed [v] is greater than the Top Speed, the Start Speed will be set equal to the Top Speed.

2. Top Speed should always be greater than or equal to the Start Speed and Cutoff Speed. Changing the Top Speed will modify the Cutoff Speed and Start Speed if they were improper, but will not modify the stored Start Speed. For instance, values of 750, 100 and 1200 will cause the pump to run simply at the top speed of 100.

3. Cutoff Speed [c] should always be less than or equal to Top Speed [V] and greater than or equal to Start Speed [v]. Changing the Cutoff Speed will not modify the Start Speed or Top Speed. However, if Cutoff Speed is greater than Top Speed it will be ignored and the Cutoff Speed will be set equal to the Top Speed. And if the Cutoff Speed is set less than Start Speed, it will be ignored and the Cutoff Speed will be set equal to the Start Speed.

3.5.5 Control Commands

R Execute Command or Program String

The [R] command tells the pump to execute a new or previously loaded but unexecuted command string. This command will also cause the resumption of a halted ("H") or terminated ("T") command string.

Commands containing [R] at the end of the string will execute immediately. If the command or program string is sent without the [R], it is placed in the command buffer.

Sending the [R] alone will execute the last unexecuted command in the buffer. Sending another [R] will not repeat the program string (i.e., the string has been executed).

X Execute the Last Command or Program String

The [X] command repeats the last executed command or program string.

G <n> Repeat Command Sequence

This command repeats a command or program string the specified number of times. If a GR or a GOR is sent, the sequence is repeated until a Terminate command [T] is issued. The G command can be used to nest up to 10 loops and can be repeated up to 48,000 times.

The syntax for this command is:

[G<n>]

where <n> = 0..48000

For example, [A3000A0G10R] moves the syringe plunger to position 3000 then back to position 0. This sequence is repeated 10 times.

g Mark the Start of a Repeat Sequence

The [g] command is used in conjunction with the [G] command. The [g] command marks the beginning of a repeat sequence (loop) that occurs within a program string (i.e., the entire string is not repeated). Both the [g] and [G] commands can be used to nest up to 10 loops.

Table 3-7, Example Program String, shows the various segments of the command string [A0gP50gP100D100G10G5R].

Command Segment	Description
A0	Move plunger to position 0
g	Outer loop start.
P50	Move plunger down 50 increments.
g	Inner loop start.
P100	Move plunger down 100 increments
D100	Move plunger up 100 increments.
G10	Inner loop, repeat 10 times.
G5	Outer loop, repeat 5 times
R	Execute command string

Figure3-7 Example Program String

M <n> Delay Command Execution

The [M] command delays execution of a command in milliseconds to the closest multiple of five. This command is typically used to allow time for liquid in the syringe and tubing to stop oscillating, thereby enhancing precision. The syntax for this command is:

[M<n>]

where <n> = 0..30,000 milliseconds (5 is the default)

H <n> Halt Command Execution

The [H] command is used within a program string to halt execution of the string. To resume execution, an [R] command or TTL signal must be sent.

The syntax for this command is:

[H<n>]

where $\langle n \rangle = 0..2$

Two TTL inputs are available, input 1 (P11 pin 7) and input 2 (P11 pin 8). They control execution as follows:

$\langle n \rangle = 0$ Waits for [R] or either input 1 or 2 to go low

$\langle n \rangle = 1$ Waits for [R] or input 1 to go low

$\langle n \rangle = 2$ Waits for [R] or input 2 to go low

Note: If the value of $\langle n \rangle$ is not specified, $\langle n \rangle$ defaults to 0.

The status of the TTL input lines can also be read by using [?13] and [?14].

These commands are described in “Report Commands” later in this chapter

T Terminate Command

The [T] command terminates plunger moves in progress ([A], [a], [P], [p], [D] and [d]), control loops, and delays [M].

Note: The [T] command will not terminate Valve Move commands. The [T] command will terminate both single commands and program strings. If a program string is terminated before completion, the [R] (Execution) command will resume the program string. If the command was terminated due to a problem or error, the pump must be reinitialized.

Caution! When a plunger move is terminated, lost increments may result. Reinitialization is recommended following termination.

Note: The [T] command (frame type 0) is valid in CAN communication. An equivalent command is ASCII 4 for frame type 2.

For “H” command and “T” command: In the string containing “H” command, the execution of the string will stop when the execution command encounters the “H” command, and the “R” command should be sent to execute the following instructions of the “H” command. When the subsequent instructions are executed, sending the “R” command will re-execute this instruction containing the “H” command; For a command that is being executed, sending the “T” command will terminate the movement being executed, and then send “R” command will re-execute the remaining string command.

J $\langle n \rangle$ Auxiliary Outputs

The [J] command sets the TTL output lines.

The syntax for this command is:

[J $\langle n \rangle$]

where $\langle n \rangle = 0..7$ (0 is the default)

SY03B provides three TTL outputs on P11 (pins 13, 14, and 15) that correspond to outputs 1, 2, and 3.

They are controlled as shown in the following table:

Command	Output 1 (pin 13)	Output 2 (pin 14)	Output 3 (pin 15)
J0	0	0	0
J1	1	0	0
J2	0	1	0
J3	1	1	0
J4	0	0	1
J5	1	0	1
J6	0	1	1
J7	1	1	1

0 = low; for example, Gnd

1 = high; for example, +5V DC

3.5.6 Non-Volatile Memory (EEPROM) Commands

The non-volatile memory in the SY03B can store a program string thus providing the user with the option of computer-free operation. The pump can be configured to run stored programs using the U<30> command. See “Pump Configuration Commands” earlier in this chapter.

s < n > Load Program String into Non-Volatile Memory

The [s] command is placed at the beginning of a program string to load the string into the non-volatile memory. The syntax for this command is:

[s<n>]

where <n> = 0..14

Up to 15 program strings (numbered 0 through 14) can be loaded into the non-volatile memory. Each string can use up to 128 characters.

For example, [IA3000OA0R] requires 10 bytes.

Example Program String: [s8ZS1gIA3000OA0GR]

Command Segment	Description
s8	Loads string into program 8 of non-volatile memory (Address switch position 8)
Z	Initializes pump
S1	Sets plunger speed
g	Marks start of loop
I	Turns valve to input position
A3000	Moves plunger to position 3000
O	Turns valve to output position

A0	Moves plunger to position 0
G	Endlessly repeats loop
R	Executes command string

e < n > Execute Non-Volatile Memory Program String

Non-volatile memory command strings are executed by sending an [e] command. The executing program string can be terminated using the [T] command.

[e<n>]

where <n> = 0..14 (the string number)

Note: An Initialization command should always be included in the non-volatile memory command string if the pump will be used in standalone mode.

U30 Set Run from Non-Volatile Memory Auto Mode

The [U30] command sets the “Run from Non-Volatile Memory Auto Mode” flag in the non-volatile memory and begins operating the pump in stand alone mode. The pump will run one of 15 command strings <n> as selected by the address switch,

where <n> = 0..E

U31 Clear Run From Non-Volatile Memory

The [U31] command clears the “Run from Non-Volatile Memory Auto Mode” flag in the EEPROM and begins operating in the default mode.

Linking Program Strings in the Non-Volatile Memory

Non-volatile memory program strings can be linked by ending one program string with an [e] command that refers to a second program string.

Example Program Strings:

[sZgIA3000OA0G5e2R]

[s2gIA3000OgHD300G10GR]

The first string loads an initialization and prime sequence into program 1 of the non-volatile memory (address switch position 1). It then links to string 2 in the non-volatile memory.

The second string loads an aspirate and dispense sequence into program 2 of the non-volatile memory. The second non-volatile memory program string fills the syringe, then performs 10 dispenses of 300 increments each. The dispenses are triggered by an [R] command. This string is repeated endlessly until the pump is powered down.

On power-up the pump will automatically initialize, prime and perform the multiple dispenses until it is

again powered down.

3.5.7 Report Commands

Report commands do not require an [R] command.

? Report Absolute Plunger Position

The [?] command reports the absolute position of the plunger in half-steps[N0] or in microsteps [N1, N2].

? 1 Report Start Speed

The [?1] command reports the start speed in pulses/sec [50..1000]

? 2 Report Top Speed

The [?2] command reports the top speed in pulses/sec [5..12000]

? 3 Report Cutoff Speed

The [?3] command reports the cutoff speed in pulses/sec [50..5400]

? 4 Report Actual Position of Plunger

The [?4] command reports the plunger encoder position in increments.

? 6 Report Valve Position

The [?6] command reports the valve position in mnemonics (i = input, o =output, e = extra, and b = bypass for non-distribution valves.

For distribution valves, the [?6] command reports ASCII values 1..X, where X is the number of distribution valve ports.

? 10 or F Report Command Buffer Status

The [?10] or [F] command reports the command buffer status. If the buffer is empty, the pump returns status code 0. If the buffer is not empty, the pump returns a 1. If a program string is sent to the pump without an [R] command, the string is loaded into the buffer and the buffer status becomes 1. An [R] command will then execute the command stored in the buffer.

0 = empty

1 = commands in buffer

? 12 Report Number of Backlash Increments

The [?12] command reports the number of backlash increments as set by the "K" command.

? 13 Report Status of Auxiliary Input #1 (P11, Pin 7)

0 = low

1 = high

? 14 Report Status of Auxiliary Input #2 (P11, Pin 8)

0 = low

1 = high

? 15 Report Number of Pump Initializations

Command [?15] reports the number of pump initializations. This value cannot be reset.

? 16 Report Number of Plunger Movements

Command [?16] reports the number of plunger moves. This value cannot be reset.

? 17 Report Number of Valve Movements

Command [?17] reports the number of valve movements. This value cannot be reset

? 18 or % Report Number of Valve Movements (Since Last Report)

The [?18] or [%] command reports the number of valve movements since the last [?18] or [%] command.

? 24 Report the Zero Gap increments

The [?24] command reports the value set by the “k” command. The value reported is in half steps (N=0) or in microsteps (N=1, N=2).

? 25 Report Slope Code Setting

The [?25] command reports the slope code setting as set by the “L” command.

? 28 Report Current Mode

The [?28] command reports the current mode as set by the “N” command (normal, fine positioning, or microstep).

? 29 or Q Report the Device Status

The [?29] command reports device status (error code).

? 76 Report Pump Configuration

The [?76] command reports pump configuration in ASCII text.

? 200 Verify conf file

[?200]

? 201 Query log

[?201]log is used to record the current device status, The log can be queried only when there is an error

again, normally, the log is 0.

? 202 Query sequence number

[?202] can be used to query the sequence number of the current device, and the sequence number of each device is unique.

?203 Query encoder

[?203]value= $n/(2*200)*920$ n:The value of the plunger from the zero point

? 300-? 314 Query the program string of s0-s14

[?300] Query the program string written in s0

* Report Voltage

The [*] command reports the value of the device power supply. The value is multiplied by 10. For example, if $V = 24.0$ VDC, the * command reports 240

< Report User Data

The [<] command returns the value of user data stored in the EEPROM. The value <n> is between 0 and 15; 0 is the default.

3.6 Error Codes and Pump Status

The [Q] command is used for serial communications and reports error codes and pump status (ready or busy). The user should send a [Q] command before sending a program string or individual command to ensure that the pump has completed the previous command successfully.

Note: [Q] is the only valid method for obtaining pump status in serial mode.

Note: [Q] command (the status byte) provides two items of information: Pump status (bit 5) and error code (bits 0-3).

3.6.1 Status Bit

Bit 5 is the status bit. It indicates when the pump is busy or not busy. The designations for bit 5 are listed below.

Status Bit 5	Description
X = 1	Pump is ready to accept new commands.
X= 0	Pump is busy and will only accept Report and Terminate commands.

In response to uppercase Move commands ([A], [P] and [D]), the [Q] command reports that the pump is busy. In response to lowercase Move commands ([a], [p]and [d]), the [Q] command reports that the pump is

not busy. Additionally, commands addressed to multiple pumps at once cannot be used to obtain pump status; pumps must be queried separately.

Note: Although the answer block for other commands contains a status bit, it should not be used for determining pump status. A [Q] command is the only valid method to determine if the pump is busy. The error information in the status byte of the answer block is always valid.

3.6.2 Error Codes

Error codes describe problem conditions that may be detected in the SY03B (excluding error code 0). Error codes are returned in the least significant four bits of the status byte. If an error occurs, the pump stops executing commands, clears the command buffer, and inserts the error code into the status byte.

Some errors continue to appear, such as syringe overloads, until they are cleared by the Initialization command. On a plunger overload, the device will not execute another valve or syringe Move command until it is reinitialized. The last error has precedence in the status byte. For example, if a command overflow occurs, an error 15 results. If the next command causes an error #3, the status byte reflects the error #3 (invalid operand)

Error Code	Description
0 (00H)	Error Free Condition.
1 (01H)	Initialization error. This error occurs when the pump fails to initialize. Check for blockages and loose connections before attempting to reinitialize. The pump will not accept commands until it has been successfully initialized. This error can only be cleared by successfully initializing the pump.
2 (02H)	Invalid Command. This error occurs when an unrecognized command is issued. Correct the command and operation will continue normally
3 (03H)	Invalid Operand. This error occurs when an invalid parameter (<n>) is given with a command. Correct the parameter and pump operation will continue normally
6 (06H)	EEPROM Failure. This error occurs when the EEPROM is faulty. If you receive this error, please call SY03B Systems Technical Service.
7 (07H)	Device Not Initialized. This error occurs when the pump is not initialized. To clear the error, initialize the pump.
8 (08H)	Internal failure. If this error occurs, please call SY03B Systems Technical Services.
9 (09H)	Plunger Overload. This error occurs when movement of the syringe plunger is blocked by excessive backpressure. The pump must be reinitialized before normal operation can resume. This error can only be cleared by reinitializing the pump.

10 (0AH)	Valve Overload. This error occurs when the valve drive loses increments by blockage or excess backpressure. The pump must be reinitialized before normal operation can resume. Sending another Valve command reinitializes the valve and sets it to the correct location. Continual valve overload errors are an indication the valve should be replaced.
11 (0BH)	Plunger Move Not Allowed. When the valve is in the bypass or throughput position, Plunger Movement commands are not allowed.
12 (0CH)	Internal failure. If this error occurs, please call SY03B Systems Technical Services.
14 (0EH)	A/D converter failure. This error occurs when the internal A/D converter is faulty. If this error occurs, please call SY03B Systems Technical Services.
15 (0FH)	Command Overflow. This error occurs when action commands are sent to the pump before it has completed the current action. Commands in the buffer must be executed before more commands can be sent.

Figure 3-8, Error Codes

3.6.3 Error Types

The pump handles errors differently, depending on the error type. There are four error types, which are described below.,

Immediate Errors

These include “Invalid Command” (error 2), “Invalid Operand” (error 3). After the command is sent, the answer block immediately returns an error. Once a valid command is sent, the pump will continue to function normally. Since the [Q] command is a valid command, the pump will not return an error. In this case, the [Q] command is not required.

Note: *There is no need to reinitialize the pump following this error type.*

Initialization Errors

These include “Initialization errors” (error 1) and “Device not Initialized” (error 7). If the pump fails to initialize or if an Initialization command has not been sent, subsequent commands will not be executed.

To ensure that the pump initializes successfully, send a [Q] command after the Initialization command.

- If the [Q] command indicates both a successful initialization and that the pump is ready, subsequent Move commands can be sent.
- If the [Q] command indicates the pump has not initialized, the pump must be reinitialized until the [Q] command indicates successful initialization.

- If initialization is not successful, a “Device Not Initialized” error is returned as soon as the next Move command is sent. A successful reinitialization must be executed before subsequent commands can be sent.

Overload Errors

These include the “Plunger Overload” and “Valve Overload” errors (errors 9 and 10). If the pump returns either a plunger or valve overload, the pump must be reinitialized before continuing. If another command is sent without reinitializing the pump, another overload error will be returned when the next Move command is issued. The [Q] command clears the error; however, if a successful initialization has not occurred, an initialization error is returned.

Command Overflow Error

This is error 15, and it occurs if a Move command, Set command (except [V]), or Valve command is sent while the plunger is moving. The pump ignores the command and issues an error 15. The [Q] command allows the controller to determine when the command is complete and the pump is ready to accept new commands.

Note: *There is no need to reinitialize the pump following this error type.*

Report commands, Control commands, and the Top Speed command [V] will not return an error 15. Report and Control commands are considered valid commands during a Move. Because the pump can change speed while the plunger is moving in the 1-12000 pulses/sec range, the [V] commands will not return a “Command Overflow” error.

Caution! *All errors reported by the pump should be captured by the user software and the physical cause corrected before continuing operation. Failure to do so may result in damage to the pump or adversely affected pump performance, and void the warranty.*

Status Byte	Hex # if Bit 5 =		Dec # if Bit 5 =		Error Code	
7 6 5 4 3 2 1 0	0	or 1	0	or1	Number	Error
0 1 X 0 0 0 0 0	40H	60H	64	96	0	No Error
0 1 X 0 0 0 0 1	41H	61H	65	97	1	Initialization
0 1 X 0 0 0 1 0	42H	62H	66	98	2	Invalid Command
0 1 X 0 0 0 1 1	43H	63H	67	99	3	Invalid Operand
0 1 X 0 0 1 1 0	46H	66H	70	102	6	EEPROM Failure
0 1 X 0 0 1 1 1	47H	67H	71	103	7	Device not Initialized
0 1 X 0 1 0 0 1	49H	69H	73	105	9	Plunger Overload
0 1 X 0 1 0 1 0	4AH	6AH	74	106	10	Valve Overload
0 1 X 0 1 0 1 1	4BH	6BH	75	107	11	Plunger Move Not Allowed

01X01100	4CH	6CH	76	108	12	Internal Failure
01X01110	4EH	6EH	78	110	14	A/D converter failure
01X00000	4FH	6FH	79	111	15	Command Overflow

Error Reporting Examples

[A7000R]	Does not move the plunger and reports a “No Error” status; when queried ([Q] command), returns error. A second try returns error 3 (67)
[P6000P600R]	Moves to position 6000, then stops. A [Q] command returns an error.
[t2000R]	Returns an invalid command error immediately. The pump status is “Not Busy”
[A6000t2000R]	Returns an invalid command error immediately. The pump is “Not Busy.”
Valve in Bypass [A1000R]	Returns an error immediately; when queried ([Q] command), does not return an error.

Chapter4 Setting Up the SY03B for Application

The SY03B is capable of providing precision pumping in a wide variety of liquid handling systems. The interplay of fluid viscosity, aspiration and dispense speeds, and system geometry (syringe size, tubing inner diameter, and valve inner diameter) determine the behavior of the SY03B in a particular application. Following is a description of the hardware, fluid, and pump control parameters to be evaluated and optimized in managing these interdependencies for optimal pump performance.

4.1 Glossary

air gap

A small volume of air at the end of the output tubing or sandwiched between two fluids in the pump system tubing. Air gaps may be created by aspirating air (programmed air gaps) or by the spring action of the fluid system (inertial air gaps).

aspirate/dispense tubing

Connects the valve output port (1/4-28 thread fitting) to a sample source and destination. To ensure good breakoff, aspirate/dispense tubing tends to have a smaller I.D. than reagent tubing, and a necked-down or tapered end.

backlash

Mechanical play in the syringe drive created by accumulated mechanical clearances.

backpressure

The pressure which must be exceeded to move fluid through tubing. Backpressure is created by a combination of fluid inertia and friction.

breakoff

Describes how the last droplet of fluid exits the end of the output tubing following a dispense. Rapid or sharp breakoff means that the droplet exits cleanly with high inertia.

breakup

Undesired air gaps created by overly rapid aspiration.

carryover

Contamination of a volume of fluid by residual fluid from a previous aspiration or dispense. Carryover causes variability in final volume and concentration.

cavitation

Formation of air bubbles due to rapid pressure changes. Often caused by aspirating fluid into the syringe too quickly.

dilution effect

Reduction in sample or reagent concentration, caused by contact with system fluid or residual fluid from a previous aspiration or dispense.

I.D. ("inner diameter")

Diameter of the constraining wall of a fluid path.

priming

Completely filling the pump tubing and syringe with bubble-free fluid to allow sustained, reproducible pumping action. The air in an unprimed line acts as a spring, adversely affecting accuracy and precision.

reagent tube

Connects the valve input port (1/4-28 thread fitting) to a reagent source. Reagent tubing is used to fill the pump syringe; it tends to have a larger I.D. than aspirate/dispense tubing, and a blunt-cut end which extends into the reagent.

system fluid

A fluid used to prime the pump system that does not act as sample or reagent. Typically the system fluid is deionized water or a wash buffer and is isolated from sample or reagent fluid by an air gap to avoid intermixing.

syringe speed profile

Typically, the syringe plunger begins moving slowly, then ramps up to top speed. This allows the plunger to start moving gradually, without overloading the motor, and still provide maximum flowrate. The syringe plunger stops by ramping down in speed. This results in the most reproducible fluid breakoff for accurate dispensing.

start speed (v)

The speed at which the syringe plunger starts moving.

top speed (V)

The maximum speed at which the syringe plunger moves.

cutoff speed (c)

The speed of the syringe plunger just before stopping.

slope (L)

Acceleration (deceleration) of the syringe plunger between start speed, top speed, and cutoff speed.

volume calculation

The volume aspirated or dispensed when the syringe plunger moves a specified number of increments depending on the syringe size. To determine the number of increments required to aspirate or dispense a given volume, use the following formula:

of increments = ((pump resolution) x volume)/ syringe size

For example, to aspirate 100 μ L using an SY03B pump with 1 mL syringe, move the plunger as follows:

of increments = (6000 increments x 100 μ L)/ (1 mL x 1000 μ L/mL) = 600 increments

4.2 Optimizing SY03B Performance

Caution! Run the pump only in the upright position. Do not move the pump valve or syringe plunger without first wetting or priming the pump. For command details, see Chapter 3, "Software Communication".

To optimize SY03B performance, follow these steps:

1. Select syringe size.

Determine your volume and flowrate requirements. Select a syringe that accommodates the smallest and largest volumes to be dispensed without refill, as well as the desired flowrate (see Table 4-1, Flowrate Ranges). While smaller syringes allow better accuracy and precision, a larger syringe allows more aliquots when multiple aspirations or multiple dispenses are required, and they allow better breakoff and longer seal life.

2. Select tubing.

In tubing selection, the general rule is that smaller syringes work best with smaller I.D. tubing and larger syringes with larger I.D. tubing. The M01-M05 SY-03B valve has an internal I.D. of 1.5mm, the M06-M08 valve has an internal I.D. of 1.2mm and the M09 valve has an internal I.D. of 1.0mm

3. Make pump connections.

Connect power and communications cables to the pump, install syringe and tubing. Place the end of the input tubing in a reservoir of particle-free fluid; place the end of the output tubing in a waste reservoir.

4. Check communications to the pump.

–Open the Pump:Link program to the SY03B menu (full page), or use your own communications program.

–Send the command [?29] to read the pump's current status. Successful communication will return to the "Ready" status.

Possible errors:

–No response. Check for loose or incorrectly connected cables, or connection to the wrong computer COM port. Retry.

5. Initialize pump and set initialization speed

The following information assumes that your input tubing connects to the right valve port. If your input tubing connects to the left valve port, exchange [Y] for all instances of [Z] in the following commands.

- Send the command [ZR] to initialize the pump. Successful initialization will move the syringe plunger to the position “0” (fully dispensed) and return the “Ready” status.

Possible errors:

- Error 1 (initialization error). Check for tubing blockage and reinitialize. If you are using very narrow I.D. tubing or pumping a viscous fluid, the initialization speed may need to be reduced.

- This is accomplished (only if using a 1 mL or larger syringe) by sending the command [Z16R] (initializes at full-force, reduced speed). Repeat with decreasing initialization speed (increase “Z_” value) until the pump successfully initializes.

6. Prime the syringe

- Send the command [IA6000OA0R] to pull fluid through the valve input position and into the syringe.
- Inspect the pump tubing and syringe for bubbles and re-prime until all bubbles are completely gone.

If bubbles remain after several priming strokes, disassemble the syringe and clean it with alcohol. Also check to ensure the fittings are tight and the syringe is tight within the Teflon fitting.

- Re-prime.

Possible errors:

- Error 9 (plunger overload). See step 8.

7. Check aspirate/dispense.

Send the command [IA6000OA0R] to aspirate a full syringe stroke (6000 increments) from input and dispense it to output. Successful execution will move the syringe plunger to position “6000” then back to “0,” then it will return a “Ready” status.

Possible errors:

- Error 9 (plunger overload). The stepper motor is unable to move the syringe plunger, probably because of excessive backpressure caused by excessive flowrate, narrow tubing I.D., or valve or tubing blockage. Note whether the error occurred during aspiration or dispensing. To differentiate between blockage and flowrate limitation, reduce syringe plunger speed by sending the command [S12IA3000OA0R]. Repeat with decreasing

plunger speed (increase “S_” value) until the pump aspirates and dispenses successfully.

8. Set start speed and top speed.

The SY03B plunger speed can be controlled from 1.2 seconds per stroke to 160 minutes per stroke (top speed) using the [S] or [V] commands. (The [V] command allows a slightly larger speed range.) As a general rule, aspiration should be slow (to avoid cavitation) and dispense fast (to promote breakoff). Since cavitation and breakoff will affect both accuracy and precision, speed settings may be optimized separately for aspiration and dispense.

Using aspirate/dispense commands, set start speed [v] and top speed [V] to meet application throughput goals.

- Send the command [v50IA6000OA0R]. Repeat with increasing start speed (increase “v_” value) to find the maximum value.
- Send the command [vxVxIA6000OA0R] to set top speed equal to start speed (x). Repeat with increasing top speed (increase “V_” value) to the maximum value that does not overload the plunger or cause cavitation.

Now optimize start speed and top speed for dispensing using a similar approach.

9. Set cutoff speed and slope

Using aspirate/dispense commands, set slope [L] and cutoff speed [c] to attain reproducible breakoff. Note that cutoff speed controls only dispensing. To optimize the slope, send the command [vxVxL14IA6000OA0R]. Repeat with modified slope (“L_” value) to achieve the overall time suited to your application without plunger overload.

To optimize the cutoff speed, start with the maximum cutoff speed allowed for your application (the lower of 2700 Hz or the top speed). Send the command [cxIA6000OA0R] and monitor the dispense for plunger overload or any splattering of the fluid dispensed outside of the dispense vessel. If any of these conditions occur, lower the cutoff speed until the pump can dispense the fluid with clean breakoff.

Another condition that affects breakoff is the formation of inertial air gaps. This is seen as a small air gap inside the tubing at the tip. This occurs to a greater extent on larger reagent syringes, and it enhances the breakoff of liquid from the tip of the tubing. If an inertial air gap is not desired in the application, lowering the cutoff speed and/or the top speed will remove the inertial air gap. However, this may not give a clean breakoff of the fluid.

Increasing the cutoff speed and ramp (slope) may also improve the fluid breakoff. Smaller I.D. tubing may improve breakoff, especially for smaller syringes.

Note: It may not be possible to achieve good fluid breakoff under any circumstance, especially with syringes smaller than 500 μL or with some fluids.

4.3 Helpful Hints

To maintain pump performance, keep the following in mind when operating the SY-03B:

- Wipe up all spills immediately.
- Pumping cold fluids may cause leaks, the result of differing coefficients of expansion of Teflon and glass. Leaks may occur when pumping fluids that are at or below 15°C (61°F).
- To reduce the amount of carryover, a ratio of three parts reagent to one part sample is recommended.
- Replace the valves and syringe seals as needed. (Interval may vary depending on the application.)

A Communication Commands

Command Type	Command	Valid/Invalid
Initialization	Z, Y, W	Valid
Initialization	z	Valid
Plunger Movement	A, a, P, p, D, d	Valid
Valve	I, O, B	Valid
Valve	E	Valid
Set	S, V, v, c, L, K, k	Valid
Command for microstep-enabled firmware	N	Valid
Control	G, g, M, H	Valid
Control	X	Valid
Control	R	Valid
Control	T	Valid
Control	Clear loaded command	Valid
Control	J, s, e, U	Valid
Report	?0 through ?314	Valid
Report	F	Valid
Report	&	Valid
Report	Q	Valid
Report	#	Valid
Report	%	Valid
Report	*	Valid

B Command Quick Reference

B.1 Pump Configuration Commands

Command	Values of <n>	Description
N	0 = fine positioning mode off	Enables or disables microstepping or fine positioning mode
	1 = fine positioning mode on	
	2 = microstep mode on	
U	30 = Set Non-Volatile Memory Auto Mode	Writes configuration information to non-volatile memory
	31 = Clear Non-Volatile Memory Mode	
	41 = Set RS baud rate to 9600	
	47 = Set RS baud rate to 38400	
	200= Set piston reset stall current (1-31, default 5)	
	300= Set device address (1-15, default 1)	
K	0...800 in full step mode (default 12)	Sets number of backlash increments.
	0...6400 in fine positioning mode (default 96)	

B.2 Initialization Commands

Command	Values of <n>	Description
Z	<n1>	Initializes the plunger drive and homes the valve in a clockwise direction
	0 = initializes at full plunger force	
	1 = initializes at half plunger force	
	2 = initializes at one-third plunger force	
	10–40 = initializes at the defined speed	
	<n2>	Sets initialization input port
	0 =Set initialization input port to Port 1	
	1 x =Set initialization input port for distribution valves, where X is the number of ports on the valve	
	<n3>	Sets initialization output port
	0 =Set initialization output port to Port X	
1 x = Set initialization output port for distribution valves, where X is the number of ports on the valve		
Y	<n1>	Initializes the plunger drive and homes the valve in a counterclockwise direction.
	0 =initializes at full plunger force	
	1 = initializes at half plunger force	
	2 = initializes at one-third plunger force	
	10–40 = initializes at the defined speed	
	<n2>	Sets initialization input ports
	0 =Set initialization input port to Port 1	
	1 x =Set initialization input port for distribution valves, where X is the number of ports on the valve	
	<n3>	Sets initialization output port
	0 =Set initialization output port to Port X	
1 x =Set initialization output port for distribution valves, where X is the number of ports on the valve		
W	<n1>	Initializes the plunger drive only (commonly used for valveless pumps).
	0 = initializes at full plunger force	
	1 =initializes at half plunger force	
	2 =initializes at one-third plunger force	
	10–40 =initializes at the defined speed	
w	<n1> 1...x =Set initialization port where X is the number of ports on the valve	Initializes the valve drive only
	<n2>>0 =Valve homes in a clockwise direction; valve ports numbered in a clockwise direction.	nitializes the valve drive only.
	1 =Valve homes in a counterclockwise direction;	

	valve ports numbered in a counterclockwise direction.	
z		Simulates initialization and sets the current position of the plunger as the home position
k	0-800 in standard mode (50 default)	Set zero gap (increments)
	0-6400 in fine positioning or microstep mode (400 default)	

B.3 Valve Commands

Command	Description
I	Moves valve to input position
O	Moves valve to output position
B	Moves valve to bypass position
E	Moves valve to extra position

B.4 Plunger Movement Commands/Status Bit Reports

Command	Value of <n>	Description	Status
A <n>	0-6000, 0-48,000 in fine positioning or microstep mode	[A]bsolute Position	Busy
a <n>	0-6000, 0-48,000 in fine positioning or microstep mode	[a]bsolute Position	Ready
P <n>	0-6000, 0-48,000 in fine positioning or microstep mode	Relative [P]ickup	Busy
p <n>	0-6000, 0-48,000 in fine positioning or microstep mode	Relative [p]ickup	Ready
D <n>	0-6000, 0-48,000 in fine positioning or microstep mode	Relative [D]ispense	Busy
d <n>	0-6000, 0-48,000 in fine positioning or microstep mode	Relative [d]ispense	Ready

B.5 Non-Volatile Memory (EEPROM) Commands

Description	Value of <n>	Description
s <n>	0..14	Loads command string in Non-Volatile Memory
e <n>	0..14	Executes Non-Volatile Memory command string
U31		Clears "Run from Non-Volatile Memory" flag.
U30		Sets "Run from Non-Volatile Memory" flag

B.6 Report Commands

Command	Description
Q	Query, Status and Error Bytes
?	Report absolute plunger position
?1	Report start speed
?2	Report top speed
?3	Report cutoff speed
?4	Report actual position of plunger
?6	Report valve position
?10 或 F	Report command buffer status
? 12	Report number of backlash increments
? 13	Report status of input #1 (P11, Pin7)
? 14	Report status of input #2 (P11, Pin 8)
? 15	Report number of pump initializations
? 16	Report number of plunger movements
? 17	Report number of valve movements
? 18 或%	Report number of valve movements (since last report)
? 20 或#	Report firmware checksum
? 23 或&	Report firmware version
? 24	Report zero gap increments
?29	Same as Q (query, status and error bytes)
?76	Report pump configuration
?200	Report conf file checksum
?201	Report log
?202	Report serial number
?203	Report encoder
?300-?314	Report the program written to the non-volatile memory
*	Report supply voltage
< <n>	Report user data (0..15)

B.7 Error Codes and Status Byte

Status Byte	Hex # if Bit 5 =		Dec # if Bit 5 =		Error Code	
7 6 5 4 3 2 1 0	0	or 1	0	or 1	Number	Description
0 1 X 0 0 0 0 0	40H	60H	64	96	0	No error

01X00001	41H	61H	65	97	1	Initialization
01X00010	42H	62H	66	98	2	Invalid command
01X00011	43H	63H	67	99	3	Invalid operand
01X00110	46H	66H	70	102	6	EEPROM failure
01X00111	47H	67H	71	103	7	Device not initialized
01X01001	49H	69H	73	105	9	Plunger overload
01X01010	4AH	6AH	74	106	10	Valve overload
01X01011	4BH	6BH	75	107	11	Plunger move not allowed
01X01100	4CH	6CH	76	108	12	Internal failure
01X01110	4EH	6EH	78	110	14	A/D converter failure
01X01111	4FH	6FH	79	111	15	Command overflow



